

Paul M. Rady Department of Mechanical Engineering Research Overview

Researchers at the [Paul M. Rady Department of Mechanical Engineering](#) work in diverse and impactful areas to improve human health, enable security and promote sustainability. Please scroll through the slides in this document to learn about their areas of expertise and potential opportunities for collaboration.



Air Quality

Peter Hamlington
Mike Hannigan
Daven Henze
Hope Michelsen
Jana Milford
Shelly Miller
Arthur Mizzi
Greg Rieker
Marina Vance
Christine Wiedinmyer



Biomedical

Alaa Ahmed
Francois Barthelat
Mark Borden
Nick Bottenus
Carson Bruns
Sarah Calve
Xiaoyun Ding
Virginia Ferguson
Jean Hertzberg
Maureen Lynch
Debanjan Mukherjee
Todd Murray
Corey Neu
Mark Rentschler
Jacob Segil
Wei Tan
Franck Vernerey
Cara Gonzalez Welker



Materials

Chunmei Ban
Francois Barthelat
Mark Borden
Carson Bruns
Sarah Calve
Longji Cui
Yifu Ding
Virginia Ferguson
Kaushik Jayaram
Se-Hee Lee
Hope Michelsen
Todd Murray
John Pellegrino
Rishi Raj
Gregory Whiting



Mechanics of Materials

Francois Barthelat
Nick Bottenus
Sarah Calve
Yifu Ding
Virginia Ferguson
Rong Long
Mark Rentschler
Massimo Ruzzene
Franck Vernerey
Jianliang Xiao
Nathalie Vriend



Micro/Nanoscale

Mark Borden
Victor Bright
Carson Bruns
Longji Cui
Xiaoyun Ding
Yifu Ding
Kaushik Jayaram
Svenja Knappe
Se-Hee Lee
Hope Michelsen
Marina Vance
Gregory Whiting
Jianliang Xiao



Robotics and Systems Design

Alaa Ahmed
Nick Bottenus
Sean Humbert
Kaushik Jayaram
Robert MacCurdy
Mark Rentschler
Jacob Segil
Nicole W. Xu



Thermo Fluid Sciences

Mark Borden
Longji Cui
Xiaoyun Ding
Peter Hamlington
Jean Hertzberg
Nicole Labbe
Hope Michelsen
Debanjan Mukherjee
John Pellegrino
Greg Rieker
Nathalie Vriend
Nicole W. Xu





Alaa A. Ahmed

Biomedical, Robotics
and Systems Design

www.colorado.edu/neuromechanics

alaa@colorado.edu

303-492-6063

Research at a Glance

The Neuromechanics Lab studies the movement biomechanics and control with the goal of reverse-engineering how the brain controls movement. We use a combination of theoretical and experimental approaches involving motion tracking, virtual reality and robotic interfaces. We employ a novel neuroeconomic approach, drawing on concepts and tools from mechanics, control theory, artificial intelligence, physiology, psychology, neuroscience and economics.

The goal of my research is to understand how the brain controls movement from neurons to algorithms to behavior.

The effortless ease with which we move masks a profound complexity. While we can now build a car that can drive autonomously for thousands of miles and rival the performance of a human driver, we still cannot build a robot that can get into that car with the grace of even a 6-year old child.

Our lab is focused on understanding what makes movement so difficult and unraveling the computational processes the brain uses to solve these problems.

Areas of Expertise

- Biomechanics and motor control
- Neuromusculoskeletal modeling
- Bayesian decision making
- Computational models of learning

Tools

- Virtual reality environments
- Robotic interfaces
- Instrumented split-belt treadmill
- Electromyography
- Motion capture
- Eye-tracking

Current projects

- What are the roles of error, effort and reward in reinforcing how the brain learns new movements?
- How does uncertainty influence the learning, consolidation and generalization of new movements?
- Is there a link between the neural systems that drive our decisions and the systems that control our movements?
- How do effort and reward influence movement vigor in individuals with Multiple Sclerosis and Parkinson's Disease?

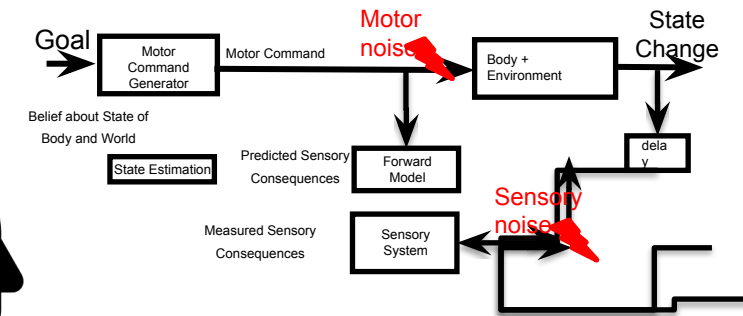
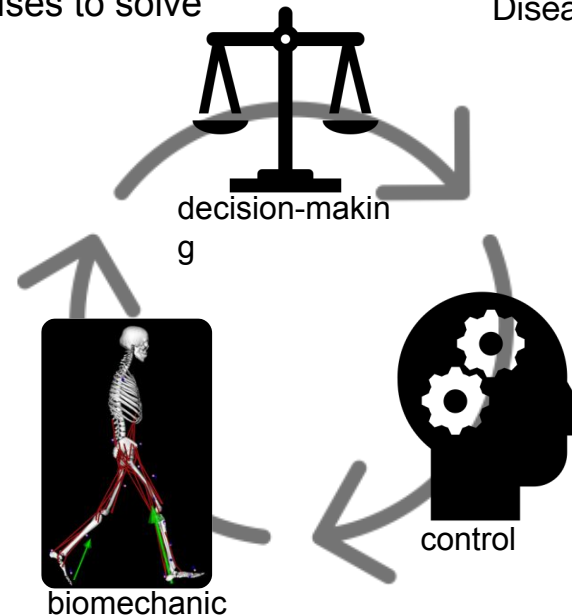



Chunmei Ban

Materials

www.colorado.edu/lab/ban/research
chunmei.ban@colorado.edu

scholar.google.com/citations?user=z1Hk5OAAAAAJ&hl=en

Research at a Glance

Provide surface engineering that provides practical solutions to stabilize next-generation energy storage systems.

Surface Engineering for a Sustainable Future

Passion and Process in Battery Research: Harnessing Nature's Bounty

The Surface Engineering Group at CU Boulder led by Prof. Chunmei Ban explores the use of surface modification to fully realize the material's potential for renewable energy technologies.

Focus areas:

1. **Surface stabilization** for electrochemical materials to improve electrochemical reactivity and reversibility (as shown in the schematic figure on the left)
2. **Multivalent electrochemical materials** for low-cost and high-energy batteries
3. **Synthesis capability** for advanced manufacturing of functional materials.

Expertise: Electrochemical analysis and characterization and surface modification systems customized for air-sensitive electrochemical materials, X-ray diffraction, transmission/scanning electron microscopy and x-ray photoelectron spectroscopy.

Our Research Expertise

Surface and near-surface Characterization

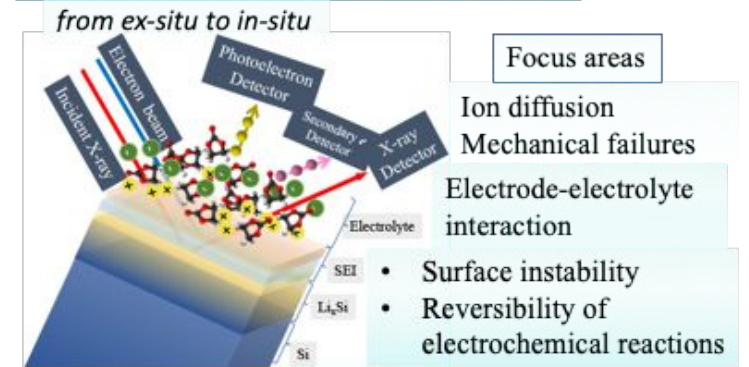

Surface stabilization from carbon to hybrid materials

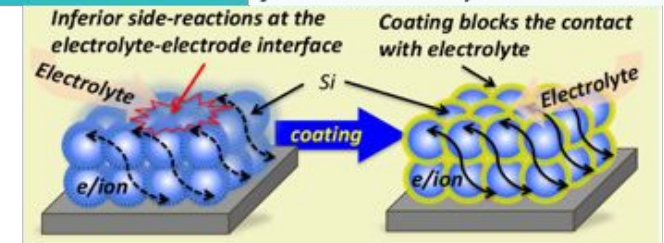



At the Laboratory for Advanced Materials and Bioinspiration, we discover and explore new concepts in materials design based on precise microarchitectures and programmable micro-mechanisms for the next generation of structural materials. Applications include transportation, biomedical and defense.

Francois Barthelat

Materials, Biomedical
Mechanics of Materials

www.colorado.edu/mechanical/francois

-barthelat

francois.barthelat@colorado.edu

303-492-8322

Research at a Glance

We combine theoretical mechanics, numerical modeling, optimization, experimental mechanics, 3D printing and also a bit of biology (for inspiration) to create, explore and validate new classes of materials. Our favorite challenge is to create new material designs that combine properties which are traditionally difficult or impossible to achieve simultaneously in individual materials.

Research Approach 1: Material Architecture

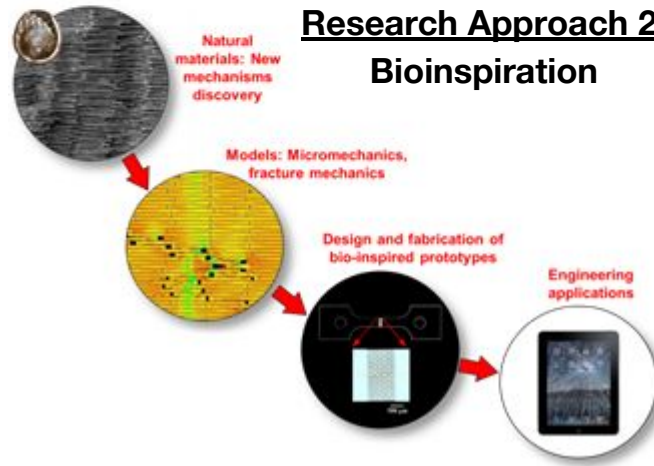
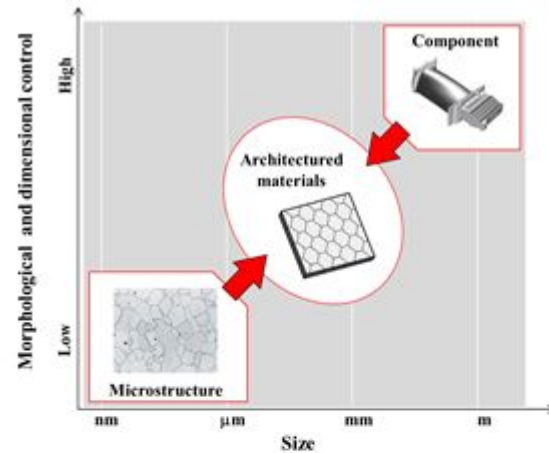

Research Approach 2: Bioinspiration

Bioinspiration

Current Projects:

New concepts and mechanics in architected materials

Fracture toughness, impact resistance, damage tolerance and self healing in architected ceramic and glasses

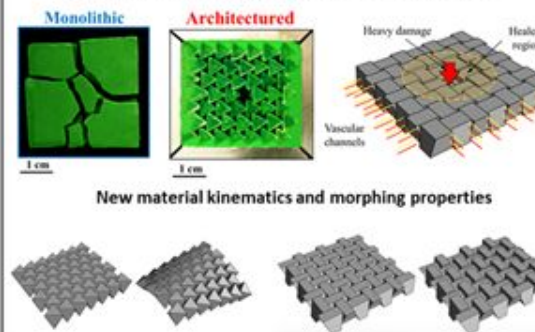

Morphing materials inspired from fish fins

Fish fins "probably represents the most elaborate and refined adaption to efficient interaction with water that has ever evolved" (Videler 1993)

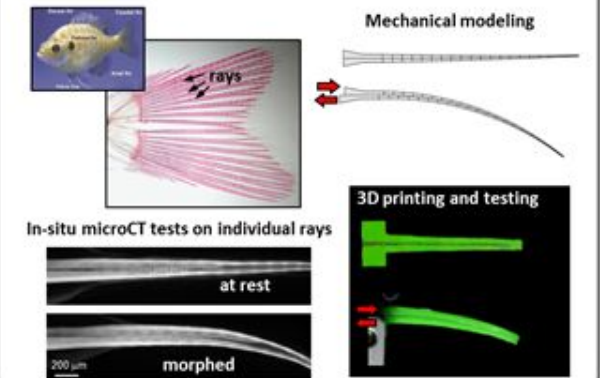

The "very hard" and the "very soft"

New mechanisms and functionalities in materials made of rigid blocks and soft ligaments

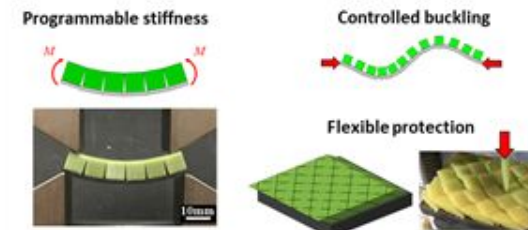

"Smart" granular materials

Design of grain geometry and mechanical stimuli for self-assembly, jamming, strength, healing and morphing

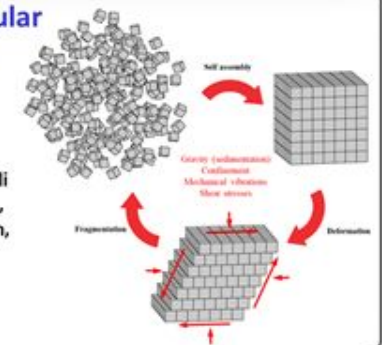



Mark A. Borden

Biomedical, Materials, Thermo Fluid Sciences, Micro/Nanoscale
www.colorado.edu/faculty/borden/mark.borden@colorado.edu
303-492-7750

Research at a Glance

My research group investigates the science and engineering of microbubbles, nanodrops and other soft colloidal suspensions for use in biomedical imaging and therapy. We employ concepts from thermofluids, colloid and interface science, acoustics, ultrasonics, biotransport, and biomedical engineering. Current applications include ultrasound molecular imaging, ultrasound image-guided drug delivery and oxygen delivery.

Borden's laboratory develops medical technology based on soft matter acoustic colloids to aid in the diagnosis and treatment of diseases, such as acute respiratory distress syndrome (ARDS), neurodegenerative diseases, heart disease and cancer.

My lab is looking to recruit self-starter **graduate students** interested making an impact on biomedicine by engineering novel imaging probes and drug delivery vehicles. Lab alumni have gone on to take faculty positions at Oxford, ETH Zurich and other universities, to startup new companies, and to take leadership positions in industry and government labs. In my lab, you will gain interdisciplinary knowledge in:

- intermolecular and surface forces in biology
- colloid and interface science
- biomedical ultrasound and acoustics
- biotransport and biointeractions
- human anatomy and physiology
- advanced medical imaging
- targeted drug, gene and oxygen delivery

We are also looking to **partner with industry**. My lab houses advanced particle characterization equipment, microscopy, ultrasound devices, imaging scanners and focused ultrasound systems. We have spun out three companies: Respirogen, TrulyOxygen, and Advanced Microbubbles Labs.

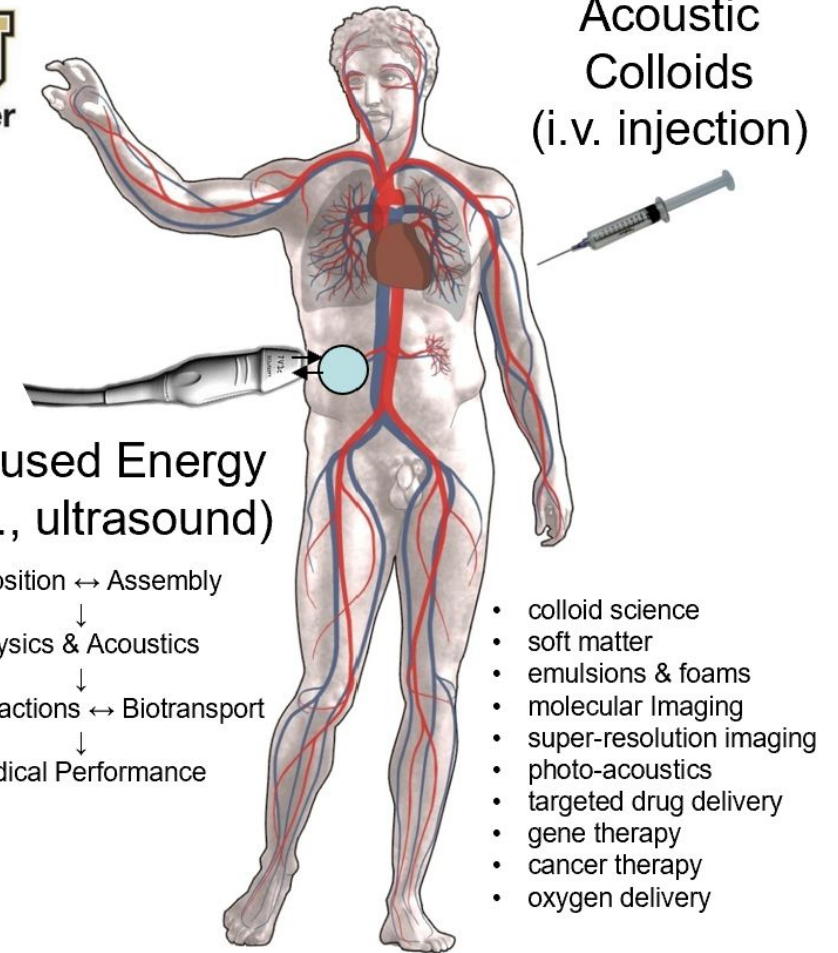



Nick Bottenus

Biomedical, Mechanics of Materials,
Robotics and Systems Design
www.colorado.edu/faculty/bottenus/
nick.bottenus@colorado.edu
303-735-7585

Research at a Glance

We design system-level solutions to clinical problems, working from scanner sequencing to signal and image processing. Our work focuses on improving ultrasound image quality in challenging imaging environments using advanced beamforming techniques.

Our mission is to bring the value of ultrasound imaging to more patients in more situations with greater clarity and utility than ever before.

Areas of expertise:

- Ultrasound pulse sequencing
- Synthetic aperture and adaptive array beamforming
- Sources of acoustic clutter and image degradation
- Ultrasonic motion estimation
- Acoustic radiation force elasticity imaging

Our capabilities:

- Ultrafast ultrasound imaging up to 20 kHz
- Real-time acquisition of up to 256 channels of raw RF array data (Verasonics Vantage)
- 3-D acoustic field measurement in a water tank
- Linear and non-linear ultrasonic simulation

Ongoing research:

Recovery of the complete data set from imaging sequences

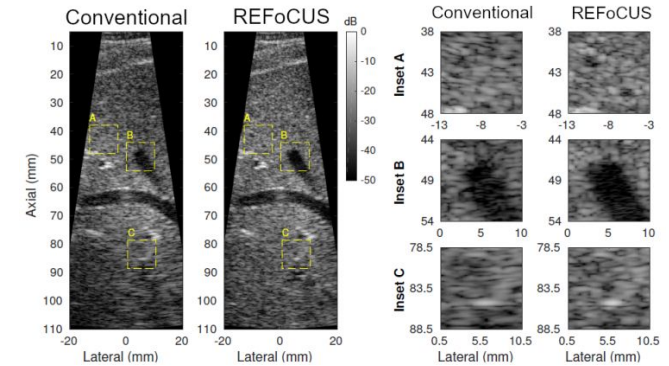

Optically-tracked and motion estimate based swept synthetic aperture imaging

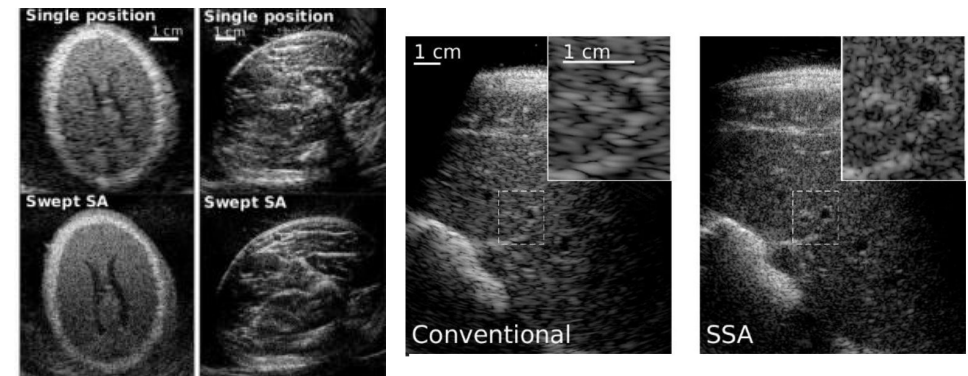



We integrate atomic, nano, and micro fabrication techniques and technologies, to develop nanoscale sensors and actuators that impact a diverse array of disciplines including physics, engineering, medicine, and biology.

Victor M. Bright

Micro/Nanoscale Systems

www.cumems.org

victor.bright@colorado.edu

Research at a Glance

Our multi-disciplinary group is committed to developing novel fabrication processes and devices that advance the field of micro- and nano-scale electromechanical systems (MEMS and NEMS). Current research directions are in applying atomic layer deposition (ALD) to create novel nanoscale sensors and developing novel tunable optics for applications such as microscopy and LIDAR using electrowetting lenses and prisms.

➤ ALD Enabled NEMS ➤ Electrowetting Optics

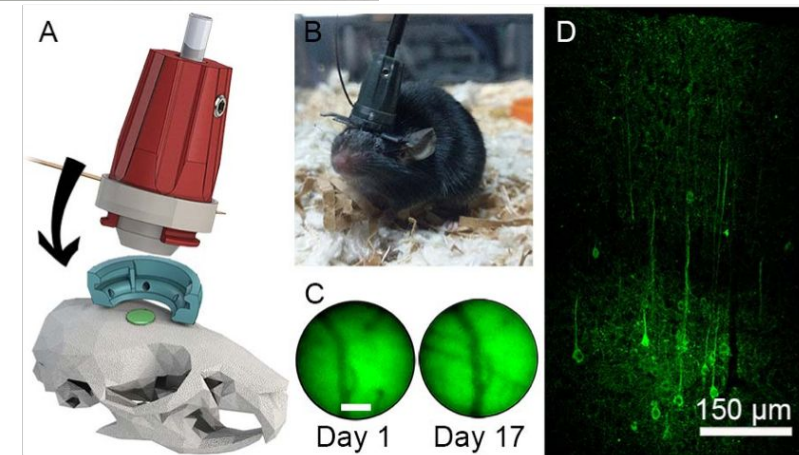
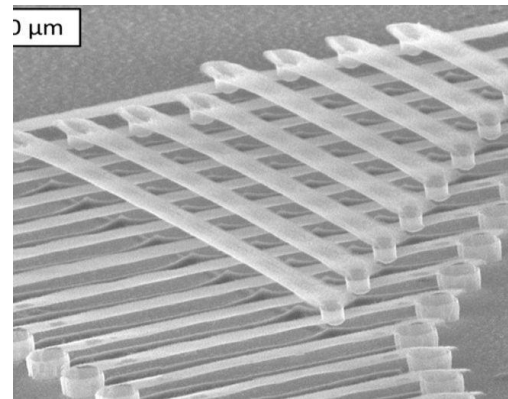
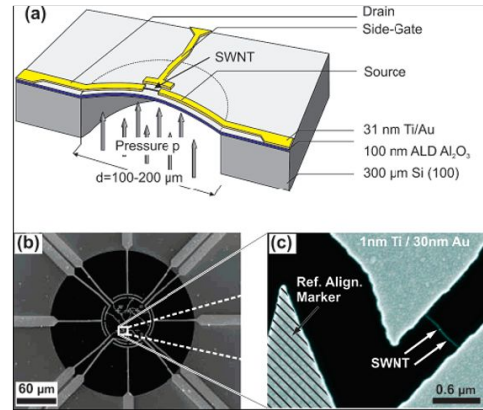
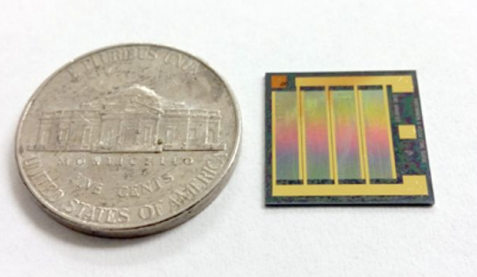
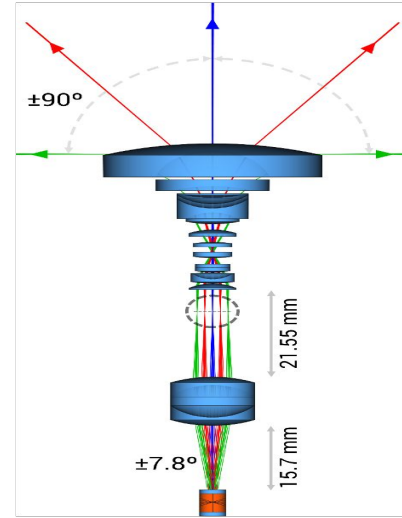
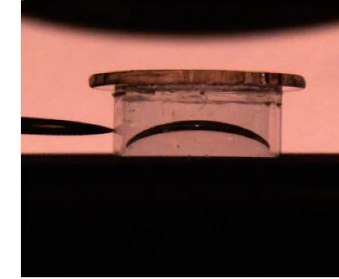
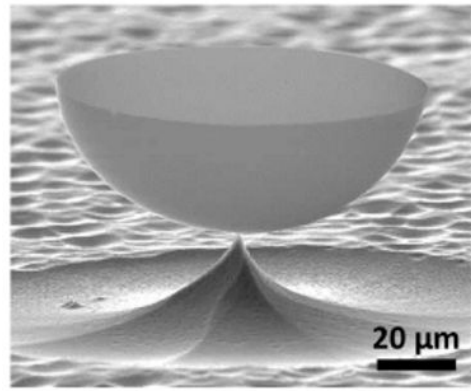



We leverage the emergent properties of nanomaterials to design technologies that solve problems in biomedical, energy, and manufacturing domains.



Research in the Emergent Nanomaterials Lab

Biomedical Tattoos



"Slide-Ring" Soft Materials

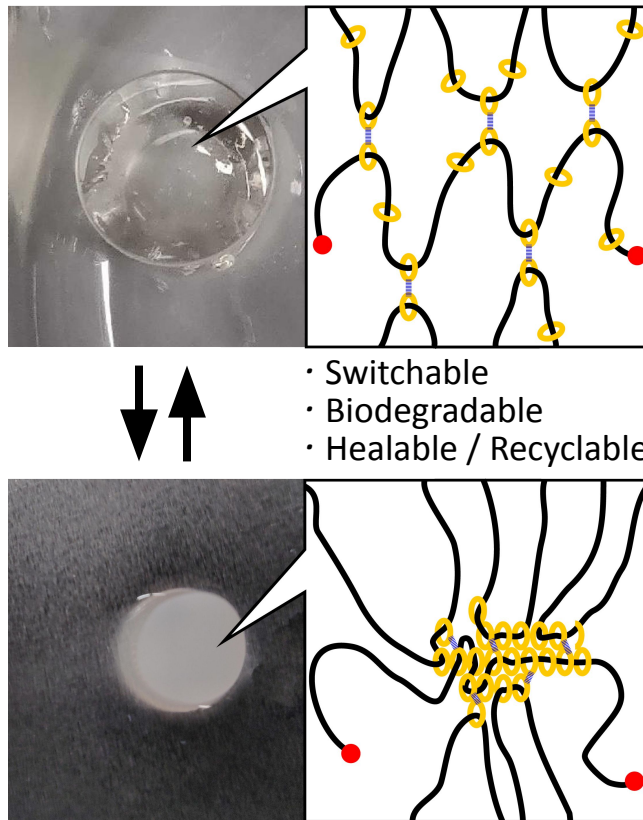

- Switchable
- Biodegradable
- Healable / Recyclable

Self-Assembly + Machines

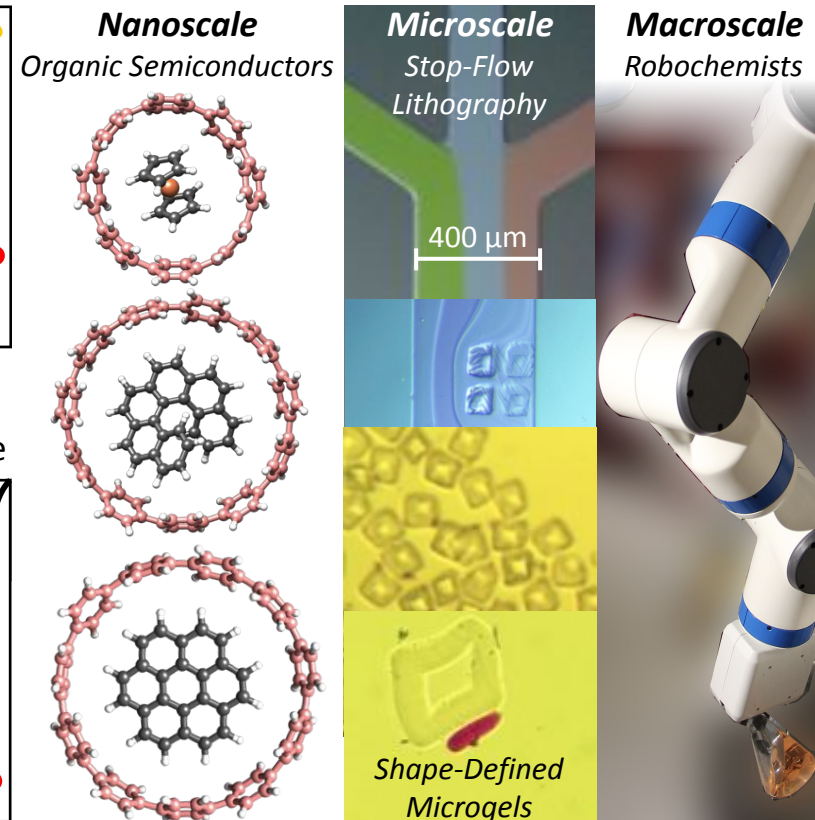

Carson Bruns

Materials, Biomedical,
Micro/Nanoscale

www.emergentnanomaterials.com

carson.bruns@colorado.edu

970-481-5269

Research at a Glance

Our interdisciplinary team combines chemistry, materials science, mechanical, electrical, & biomedical engineering to develop active materials with nanoscale features that enable them to respond to stimuli and use energy to manifest novel structures and functions.

Expertise / Capabilities: Organic, Polymer, & Colloid Synthesis · Photolithography · Shear Rheology · Spectroscopy & Microscopy



Paul M. Rady
Mechanical Engineering
UNIVERSITY OF COLORADO BOULDER

www.colorado.edu/mechanical/



Sarah Calve

Biomedical, Materials,
Mechanics of Materials

www.sarahcalve.com
sarah.calve@colorado.edu
303-492-7640

Research at a Glance

The Musculoskeletal Extracellular Matrix Laboratory is actively developing tools to quantify how the composition, turnover, organization and mechanical properties of the musculoskeletal system change during tissue assembly. The goal is to use these tools to elucidate how different extracellular matrix components integrate to form functional tissues during development, regeneration and scar-free repair.

The mission of the Musculoskeletal Extracellular Matrix Laboratory is to characterize the material properties of assembling tissues to establish design parameters for regenerative therapies.

Dynamics of extracellular matrix (ECM) synthesis

Mass spectrometry + bio-orthogonal labeling of newly synthesized proteins in vivo

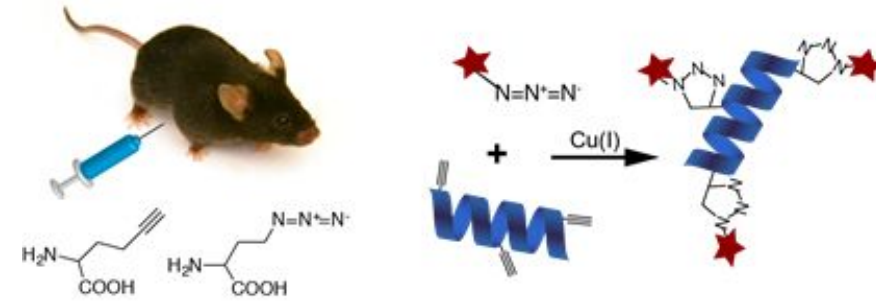

Spatial organization of ECM components

Clearing and decellularization to visualize cell + tissue architecture in 3D

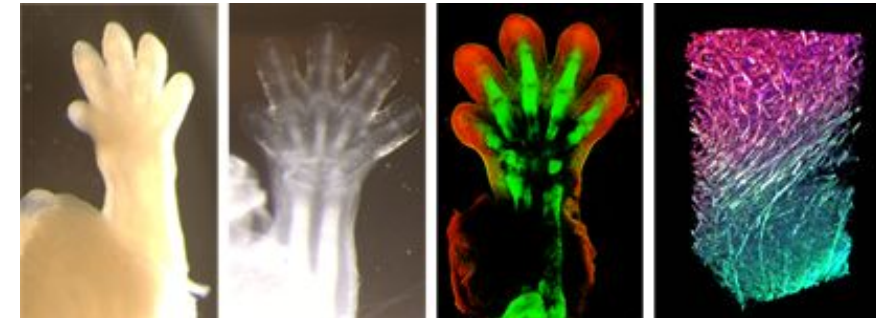

Influence of organization on ECM mechanics

Experimental and computational modeling of ECM fibril and network mechanics at the mesoscale

Prospective graduate students and postdoctoral associates motivated to integrate engineering principles with the fundamentals of biology are encouraged to email Prof. Calve: sarah.calve@colorado.edu

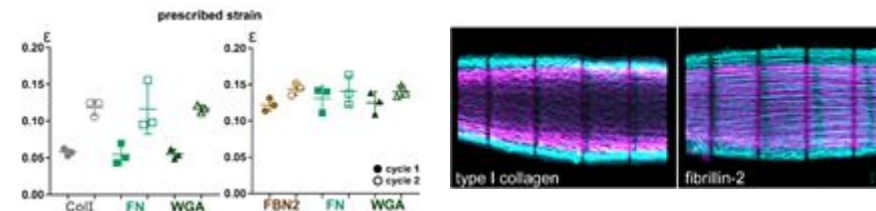

Our mission is to provide nanoengineering and nanoscience based tools and solutions to address the pressing grand challenges in the 21st century including cheap and clean renewable energy, next-generation microelectronics, and high-performance nanomaterials.



Longji Cui

Thermo Fluid Sciences,
Materials, Micro/Nanoscale

www.cuilab.org/

longji.cui@colorado.edu

303-735-8218

Research at a Glance

Our group focuses on developing nanostructures and nanoengineering tools capable of resolving energy transfer, conversion, and dissipation down to the scale of single atoms and molecules. Our research provide fundamental understandings to address the limitations existing in the performance and energy efficiency of nanotechnology-enabled thermal, electrical, and optical applications.

- Ultra-high Resolution Thermal Sensing and Imaging
- Atomic, Molecular, and Quantum Electronics
- High-efficiency Nano-thermoelectrics
- Nano-gap Thermophotovoltaics and Plasmonic Applications

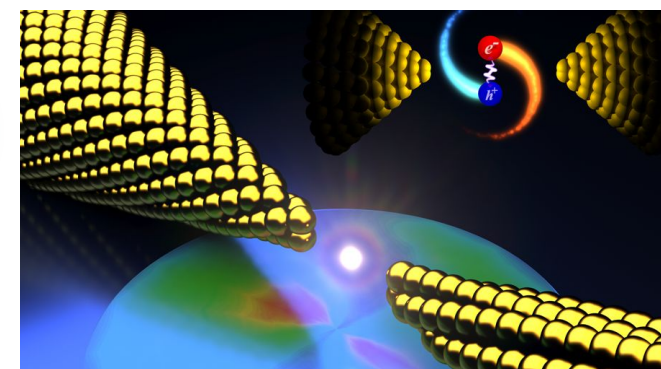
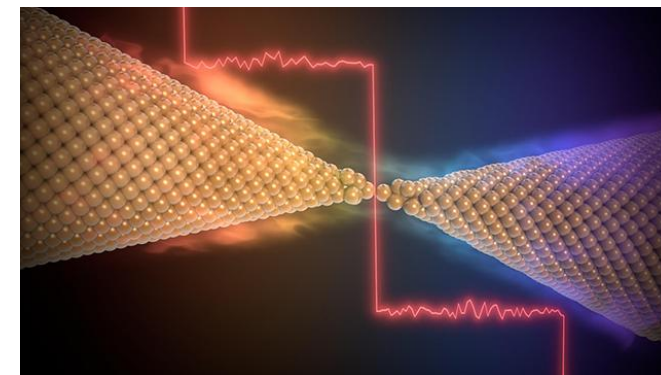
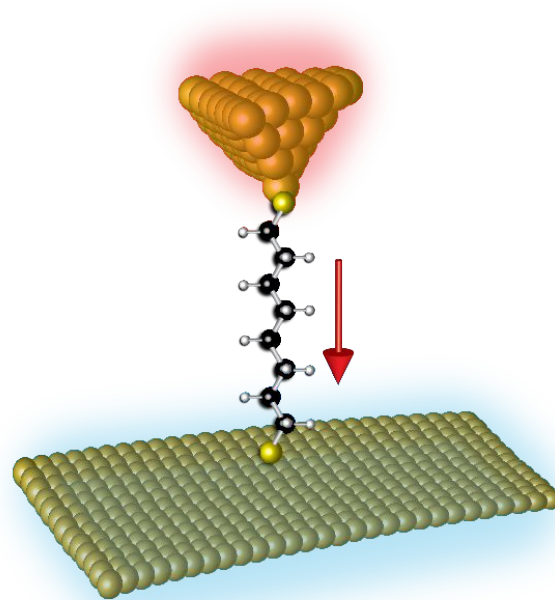
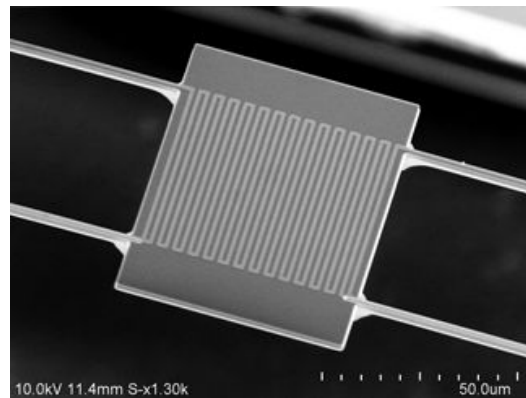
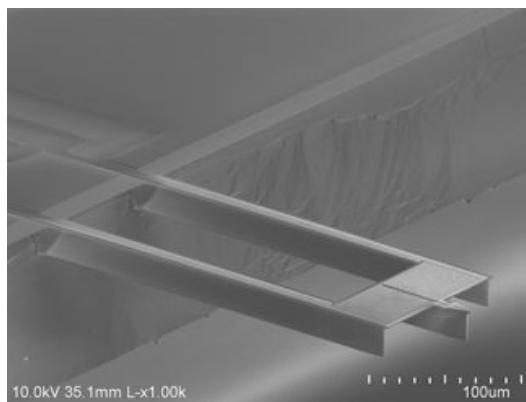



Xiaoyun Ding

Biomedical, Micro/Nanoscale,
www.colorado.edu/lab/bmmlab/
xiaoyun.ding@colorado.edu

Research at a Glance

Our group centers on interdisciplinary research at the frontiers of Micro/Nano Engineering, Biology, Medicine, and Physics. We focus on creating cutting-edge micro/nano systems and technologies for various cell based biomedical applications in life science, healthcare, and medicine. our recent focus includes cell mechanics for biomarkers, cell membrane disruption and recovery and its application for precise intracellular drug delivery in immunotherapy and gene editing, bioparticle manipulation and sensing for fast diagnosis.

We create novel Lab-on-a-Chip, Microfluidic technologies, and other Biomedical Microdevices to tackle challenges in life science and health care through cell/bioparticle manipulation, precise intracellular drug delivery, cell physics, and cellular mechanical biomarkers.

In general, we develop novel Lab-on-a-Chip and biomedical microsystem and technologies for cell based applications for fast and accurate diagnosis and therapy.



Novel Acousto Thermal Shift Assay (ATSA) for rapid and label-free protein analysis and its applications for fast disease diagnosis

ATSA Device: IDTs, Micro channel, IDTs

Protein Precipitation: Acoustic Heating

Assembly: Acoustic Force

Protein Melting Curve: $I_m = (I_{max} + I_{min})/2$

Gray intensity I vs SAW time (s)

Cell/particle Micro Manipulation

Label-free cancer cell separation

Tunable nano patterning

Cell membrane disruption and recovery and its application of precise intracellular delivery for immunotherapy and gene editing

CHMP4B-GFP, DAPI, Overlap, DIC

Plasma Membrane: # of CHMP4B-GFP Foci per Cell vs Time/min

Nuclear Envelope: # of CHMP4B-GFP Foci per Cell vs Time/min

Cell/droplet sorting

Fluids manipulation

Liquid crystal molecule alignment



Yifu Ding

Materials, Mechanics of Materials,
Micro/Nanoscale
<https://www.colorado.edu/lab/ding/>
Yifu.Ding@Colorado.edu
303-492-2036

Research at a Glance

The Nanostructured Polymer Lab focuses on understanding and controlling behaviors of polymers at surfaces and interface. We develop novel surface patterning, self-assembly, and interfacial polymerization techniques for applications ranging from separation membranes to stimuli-responsive materials.

Our lab engineers better materials and membranes for water treatment, bioseparation, gas separation and nanomanufacturing.

The Ding research group specializes in developing new techniques to spatially modify structures and surfaces of polymer films and porous membranes. Our current projects include:

- Developing surface-patterned antifouling membranes for bioseparation and desalination.
- Improving mechanical and permselective properties of dense membranes using precisely patterned mechanical heterogeneity.
- Developing elastomers with low gas permeability and low friction coefficient.
- Engineering supertough hydrogels for membrane applications.
- Understanding bonding mechanism between polymer and porous membranes for membrane device manufacturing.

We closely collaborate with industry through our Membrane Science, Engineering and Technology (MAST) center, an NSF industry university collaborative research center (IUCRC). Our lab is well-equipped with tools for

- polymer processing, fabrication, and characterization;
- membrane fabrication, characterization and process evaluation;

Antifouling membranes by surface patterning

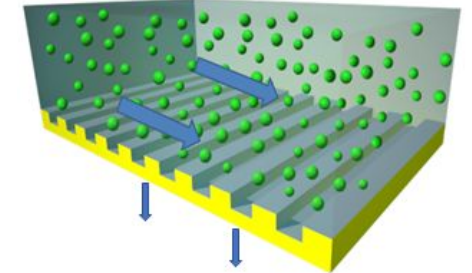
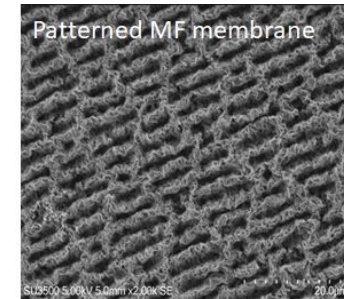

Particles, porous polymers via self-assembly

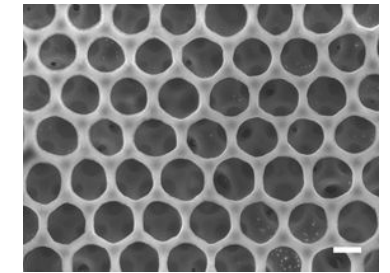
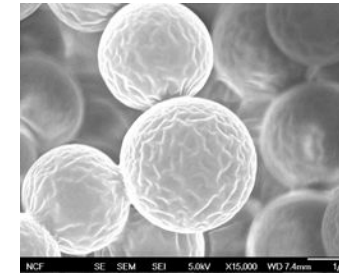

Elastomers with low permeability and friction

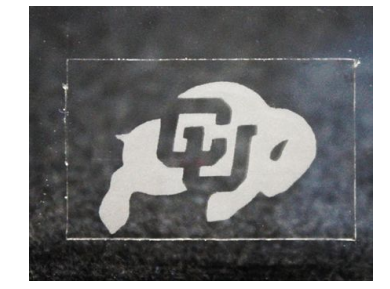
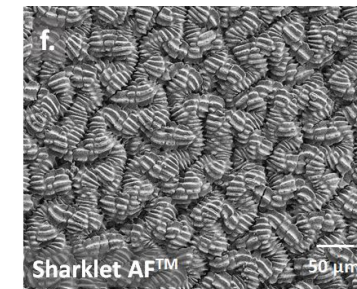



Peter Hamlington

Thermo Fluid Sciences, Air Quality
<https://teslacu.org>
peh@colorado.edu
303-492-0555

Research at a Glance

Large-scale numerical simulations on high performance computing systems, with a focus on: Turbulent flows, wildland fires, ocean biogeochemistry, geophysical fluid dynamics, ocean and wind renewable energy, reacting flows, combustion, aerospace propulsion, and industrial processing. Simulations are used to understand fundamental flow physics, to guide the development of improved reduced order models, and for optimization, parameter estimation, and uncertainty quantification.

The Turbulence and Energy Systems Laboratory (TESLa) focuses on numerical simulations of turbulence for fundamental flow analyses, model development, design optimization, and performance analysis.

There are three core areas of research in the Turbulence and Energy Systems Lab (TESLa):

1. Turbulence modeling (e.g. machine learning, parameter estimation, optimization)
2. Geophysical turbulence (e.g. upper ocean dynamics, biogeochemistry)
3. Reacting flows and combustion (e.g., fire dynamics, auto-ignition at high speeds)

In TESLa, applied research topics are examined at the intersections of core areas:

1. Propulsion and transportation (e.g. rotating detonation engines)
2. Wildland fire (e.g., fire prediction and mitigation)
3. Wind and ocean renewable energy (e.g. ocean and wind current turbines)
4. Ocean carbon cycle and contaminant transport (e.g. chemical species, plankton)

A range of advanced tools are used in TESLa:

High-performance computing, computational fluid dynamics, adaptive mesh refinement, machine learning, massively parallel simulations

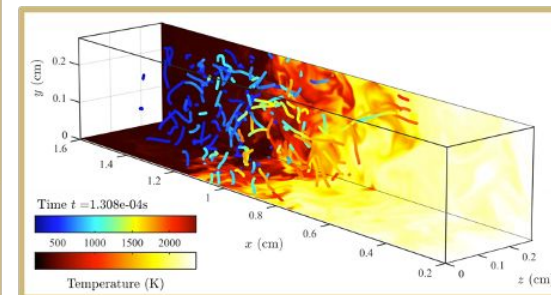
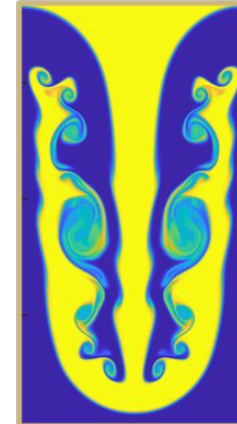
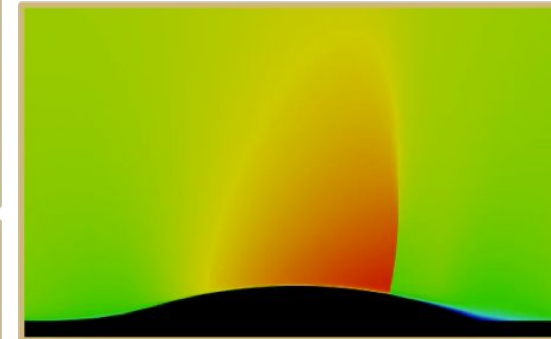
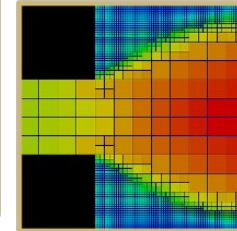
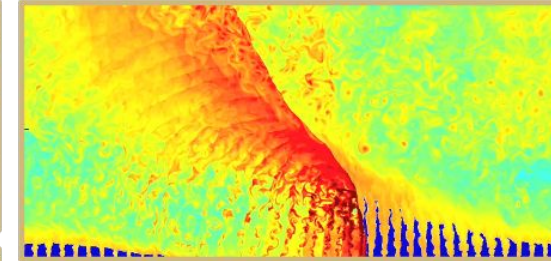
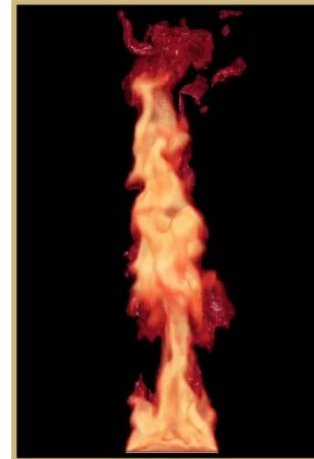

Simulations from TESLa: 1) Pool fire, 2) helium plume, 3) compressible turbulence, 4) supersonic nozzle, 5) Rayleigh-Taylor instability, 6) rotating detonation engine, 7) axisymmetric bump, 8) premixed flame





With the end goal of improving human health, we explore the links between human activities and the environment through the development and use of novel, low cost measurement systems.

Michael Hannigan

Air Quality

www.hanniganlabs.wixsite.com/cuboulder
michael.hannigan@colorado.edu

Research at a Glance

To reduce the impact of human activities on the planet, we need to (1) quantitatively understand the links between those activities and their impacts, and (2) assess the effectiveness of solutions. In the Hannigan group, we work in this space by applying novel measurement systems ... out in the world, from Africa to Los Angeles to Boulder.

The Hannigan Group is at the forefront of the use of sensors systems to assess air quality as well as household energy systems. They are also known for figuring out the origins of air quality problems.

Current research areas include:

- Developing low-cost point based systems to monitor for leaks in hydrocarbon heavy industries
- Collaborating with communities impacted by multiple air pollutant sources in LA to develop strategies to minimize harmful exposures
- Improving our understanding of particle emissions, transport and fate from wildfires
- Assessing the impact of cooking and open burning on air quality in the global south.

Current teaching activities include:

- Project-Based Learning in Rural Schools
- Statics



monitoring CH₄ and VOCs near gas facility



calibrating sensor systems in LA



monitoring open burning emissions



household waste to energy





Daven Henze

Air Quality

<https://spot.colorado.edu/~henzed>
daven.henze@colorado.edu
cuboulder.zoom.us/my/davenhenze

Research at a Glance

Our research focuses the sources and fate of atmospheric constituents (aerosols, NO_x, ozone, and long-lived greenhouse gases) and their roles on air quality, long-range pollution transport, and climate change. A large part of this research stems from chemical data assimilation, the process by which both models and observations are combined to produce estimates of the atmospheric state that are often more complete than those provided by either approach alone. This encompasses more specific interests in remote sensing, sensitivity analysis, inverse problems, and source apportionment.

Using ambient observations, satellite remote sensing, and computer simulations of the atmosphere to identify the role of human activities on the environment, air pollution, human health and climate.

Subset of Current Research Projects

- Top-down estimates of PM_{2.5} precursor emissions: SO₂, NH₃, NO₂ (NASA)
- Using remote-sensing observations to support health impact assessments and air quality policy (NASA, Wellcome Foundation)
- Emission strength and impacts of wildfires on air quality (NOAA, NASA)
- Machine-learning for AQ modeling (NASA)
- Chemical mechanism reduction using machine learning (EPA)

Consulting Activities

- Regional to global air quality model simulations (GEOS-Chem, CMAQ, WRF-Chem)
- Evaluation air quality sources and trends using satellite observations of trace-gases and aerosols
- Health impact assessment tools, i.e. estimating premature deaths owing to exposure to air pollution from a specific policy or technology scenario

Research Overview and Tools

Observations

NASA TES

Satellites

Field Measurements

+ Models

Physics & Chemistry

Supercomputers

+ Theory

$$\langle u, Lv \rangle_{\mathcal{O}} = \langle L^*u, v \rangle_{\mathcal{M}}$$

Inverse Problems and Optimization

= Control

Clean, Sustainable



Flow visualization lets us see the physics of the gases and liquids that are all around and inside us. Fluids can be beautiful or icky, useful or insignificant, but always, endlessly, fascinating.



Jean R. Hertzberg

Fluid Dynamics, Biomedical and Engineering Education Research

<https://www.jeanbzhertzberg.com>

hertzberg@colorado.edu

303-492-5092

Research at a Glance

I love flow visualization for both its beauty and utility. My fluids research is generally human-scale experimental fluid physics ranging from combustion to cardiac hemodynamics. I'm also interested in how the aesthetics of engineering can be used to promote transformative experiences in engineering education.

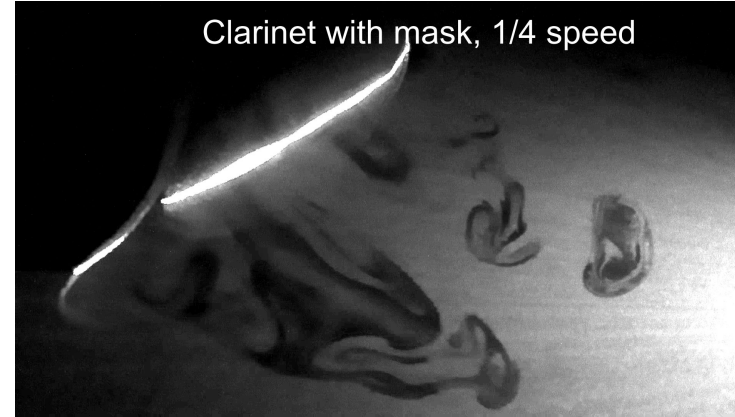
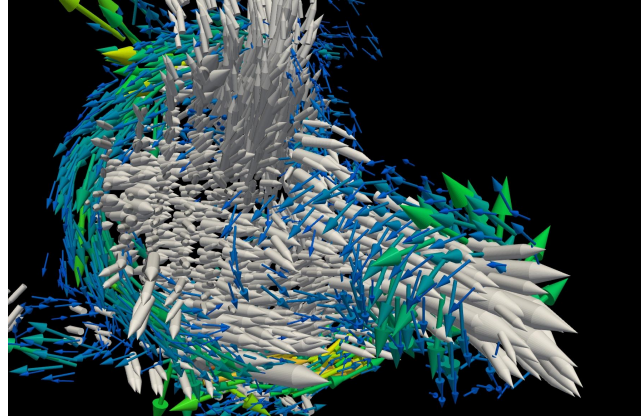

Top left: flow in a human heart. 4DMRI is an MRI imaging technique that shows blood flow velocity. Here, white pencils represent velocity, flowing from the right cardiac atrium in to the ventricle, and the colored arrows represent vorticity. These data are useful in measuring pulmonary hypertension and the damage from diabetes.

Top right: Musical instruments (brass, woodwinds) and singers emit more potentially infectious aerosols than quiet humans. This laser sheet visualization shows that masks on instruments reduce high speed flow with a minimal impact on sound.

Left: Students in a course on Flow Visualization produced this laser sheet visualization of flow from a suddenly started planar jet. Student in this course and in Aesthetics of Design report improved attitudes towards engineering.

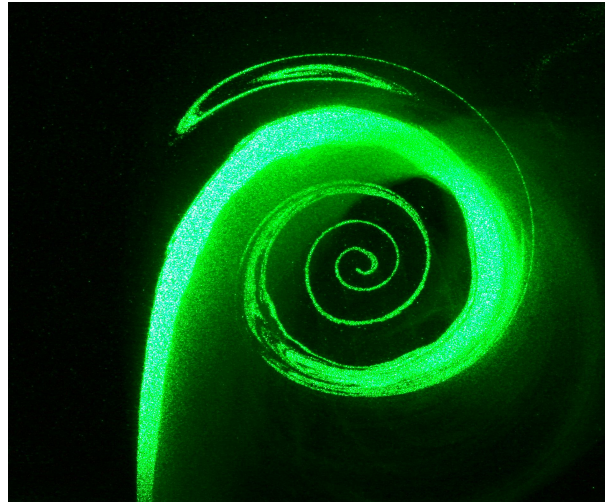



J. Sean Humbert

Robotics and Systems Design
www.boulderbprl.com
sean.humbert@colorado.edu
 301-492-8250

Research at a Glance

Main research focus is perception, reduction and feedback principles in biology. Our laboratory works with biologists to apply control- and information-theoretic tools to formalize these principles in small animals such as insects, providing insight into the biology and resulting in novel, robust and computationally efficient solutions for engineered systems.

The Bio-Inspired Perception and Robotics Laboratory (BPRL) seeks to distill the fundamental sensing, processing and feedback principles that govern robust behavior in organisms to enable new classes of robotic systems with improved agility, locomotion and autonomy.

Areas of expertise

- Reduction principles in biology
- Sensor and actuator-rich feedback principles
- Novel sensorimotor feedback architectures
- Dynamics and control of highly flexible synthetic systems
- Bio-inspired sensors and sensory processing
- Rotary wing, fixed wing and flapping wing flight mechanics, stability and control
- Autonomous navigation and collision avoidance

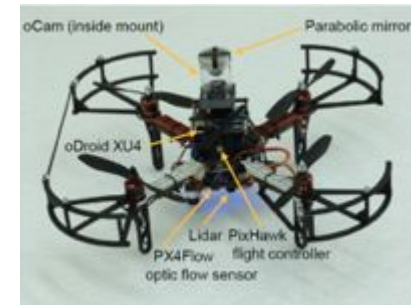
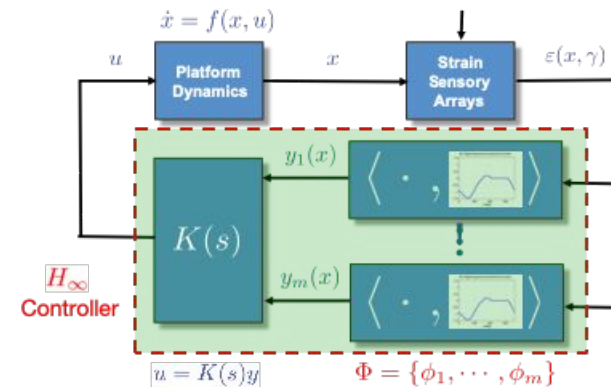
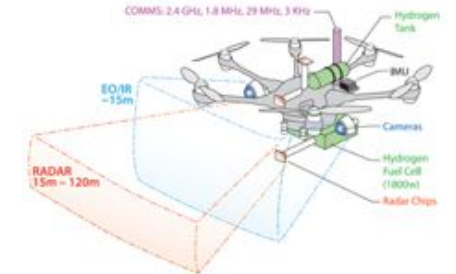
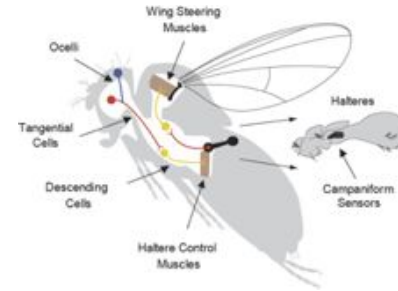
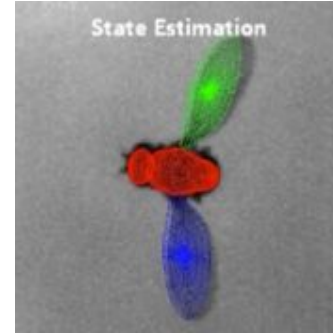
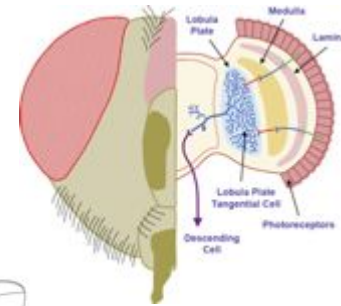



Kaushik Jayaram

Robotics and Systems Design,
Materials, Micro/Nanoscale
www.colorado.edu/lab/jayaram
kaushik.jayaram@colorado.edu
303-735-7381

Research at a Glance

Our group's research combines biology and robotics to, uncover the principles of robustness that make animals successful at locomotion in natural environments, and, in turn, inspire the design of next generation of novel robots for effective real-world operation.

Our research aims to develop a rich ecosystem of robotic devices that, in the not-so-distant future, will have the potential to benefit human lives in the areas of search and rescue, inspection and maintenance, personal assistance, and environmental monitoring.

Research Expertise:

- Bioinspired Robotics
- Biomechanics
- Locomotion Robustness
- Origami-based Design and Fabrication
- Distributed Sensing

Current Projects:

- Autonomous insect scale robots
- Spider locomotion biomechanics
- Collective communication and coordination
- Millimeter scale actuators, sensors

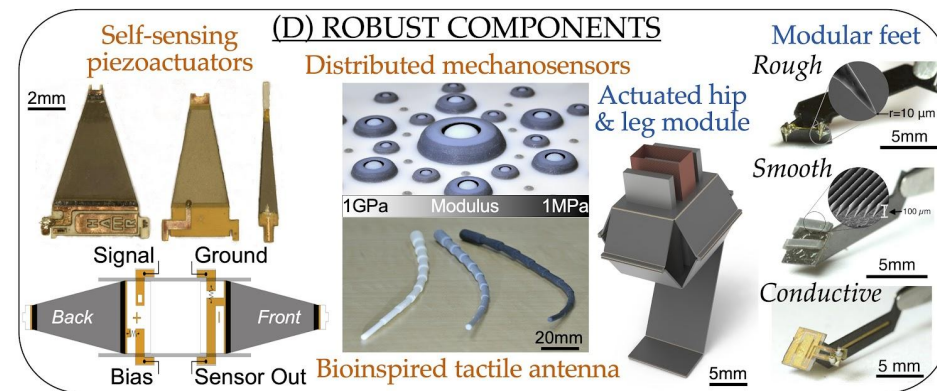
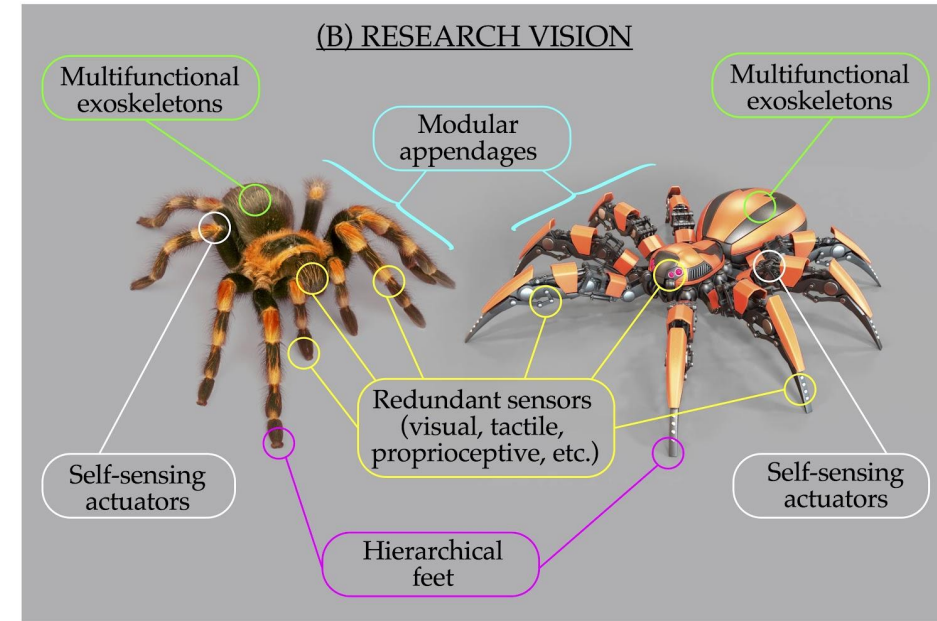
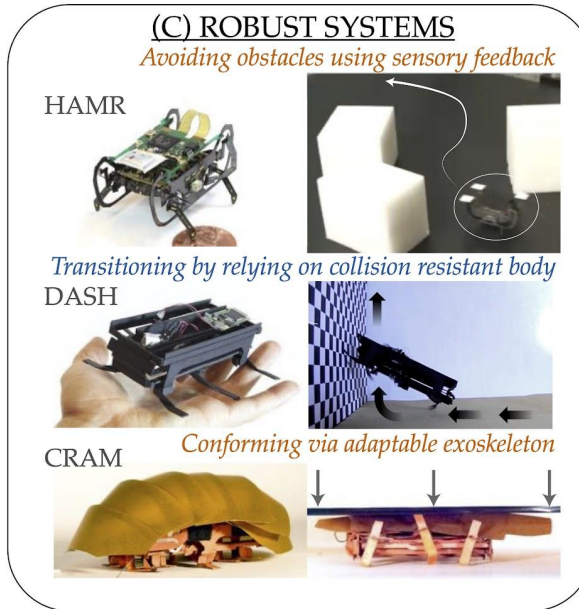
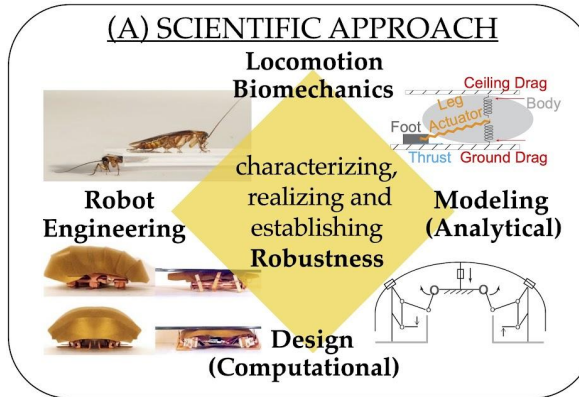



Svenja Knappe

Micro/Nanoscale

www.colorado.edu/faculty/knappe

svenja.knappe@colorado.edu

303-735-6909

Research at a Glance

Atomic quantum sensors can reach very high sensitivity and accuracy without the need for re-calibration. We are developing field-deployable quantum sensors and systems with low size weight, and power by combining microfabrication and quantum technologies to engineer these sensors into small packages. We closely work with users in aerospace, defense, brain imaging, brain-computer interfaces, and industrial applications to develop new sensor capabilities.

Combining microfabrication approaches with atomic spectroscopy, we engineer novel sensor and system technologies with direct impact in biomedical, industrial, and defense applications

Atomic Quantum Sensors

Our projects

- Optically-pumped magnetometers for conformal non-invasive brain imaging
- Unshielded non-invasive brain-machine interfaces
- Magnetographic camera for magnetic nanoparticle imaging
- Vector magnetometry from CubeSats and small unmanned vehicles
- Advanced chip-scale atomic clocks

Our expertise

- Advancement of microfabricated atomic vapor-cell technology
- Novel atomic quantum sensor development
- System engineering of compact quantum sensor systems
- Working with diverse user groups on developing new applications for atomic quantum sensors

Entrepreneurship

In 2017, Svenja Knappe founded FieldLine Inc. with Orang Alem and Jeramy Hughes with the aim to translate the quantum magnetometer technology into industry. FieldLine are currently offering magnetic imaging systems for non-invasive brain imaging, industrial, and defense applications. More information can be found at:

www.fieldlineinc.com

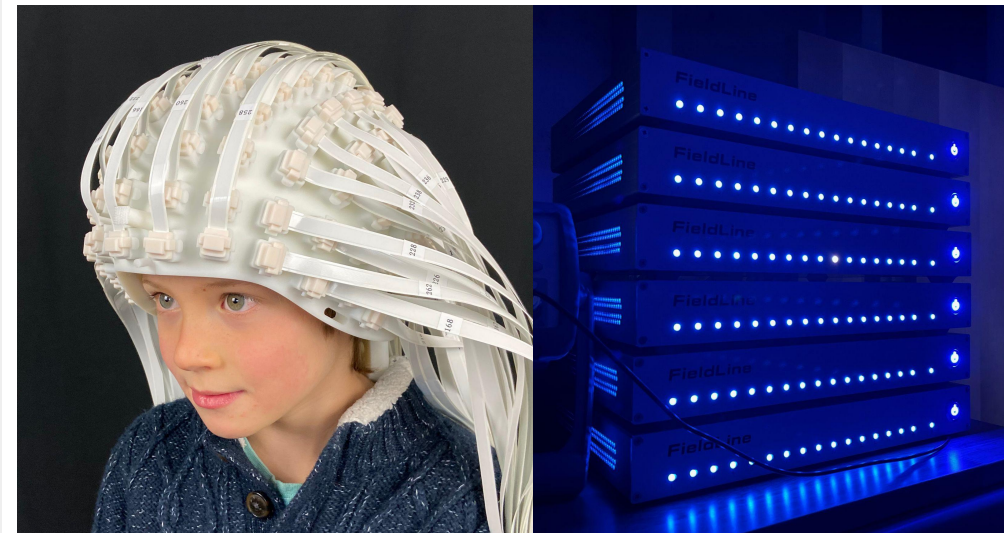



Designing new fuels that burn greener, cleaner, and more efficiently from the atom up.

Nicole Labbe

Thermo Fluid Sciences

www.thelabbelab.com

nicole.labbe@colorado.edu

303-735-4821

Research at a Glance

The Labbe Lab uses a combined experimental and theoretical approach to understand the complicated chemistry of combustion systems. With this knowledge, we are able to determine why fuels behave the way they do in engines, determine how to reduce the negative effects of combustion such as pollution, and design new fuels to make our engines run cleaner and more efficiently, often using renewable resources.

Our Expertise:

- Gas phase reaction kinetic modeling for combustion, atmospheric, and interstellar systems
- Rational fuel design for emerging transportation engine technologies
- Experimental design for molecular detection of combustion and pyrolysis intermediates
- Biofuel blendstocks for targeted combustion behavior

Our Capabilities:

- Photoionization mass spectrometry and IR Spectroscopy detection for reacting flows
- Computational chemistry expertise for reaction dynamics
- Detailed kinetic model development for gas phase reacting systems
- Hybrid manufacturing techniques for high temperature ceramics

For more information, visit: www.thelabbelab.com

Some Current Projects:

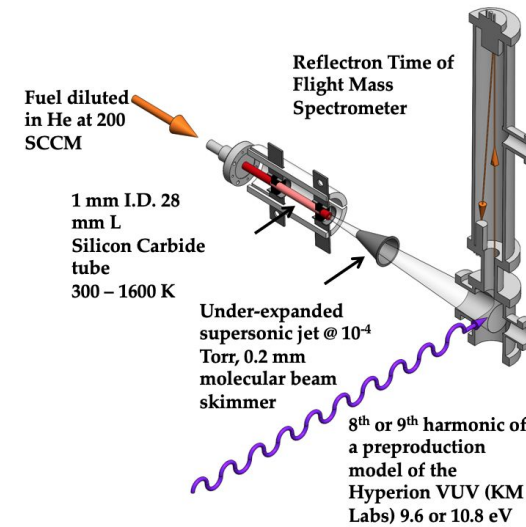

Photoionization mass spectrometry detection of biofuel pyrolysis

Hybrid manufacturing of ceramic microreactors

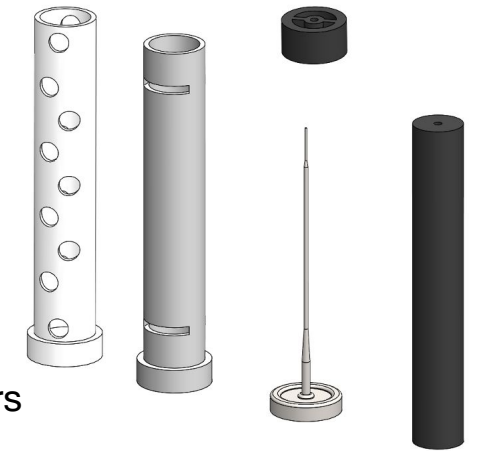



Se-Hee Lee

Materials, Micro/Nanoscale
www.colorado.edu/lab/ecel/sehee.lee@colorado.edu
 303-492-7889

Research at a Glance

The Electrochemical Energy Laboratory is set up to design and develop high performance materials for sustainable energy applications (mainly electrochemical systems such as batteries, supercapacitors, fuel cells, electrochromic windows, and photoelectrochemical devices).

Our research covers new materials design and development, chemical synthesis, materials characterization, property measurements, fabrication of prototype devices and their evaluation, and a fundamental understanding of structure-property-performance relationships of materials. Nanostructured materials including metal oxides and metal chalcogenides are being investigated.

Solid State Li Metal Batteries

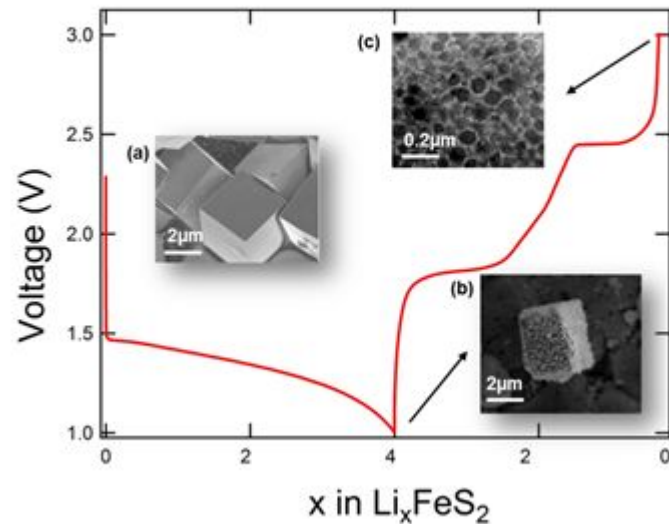

Interface Engineering for Li-ion batteries. ALD, MLD, and other vacuum depositions are being utilized.

RTIL for Advanced Li Batteries

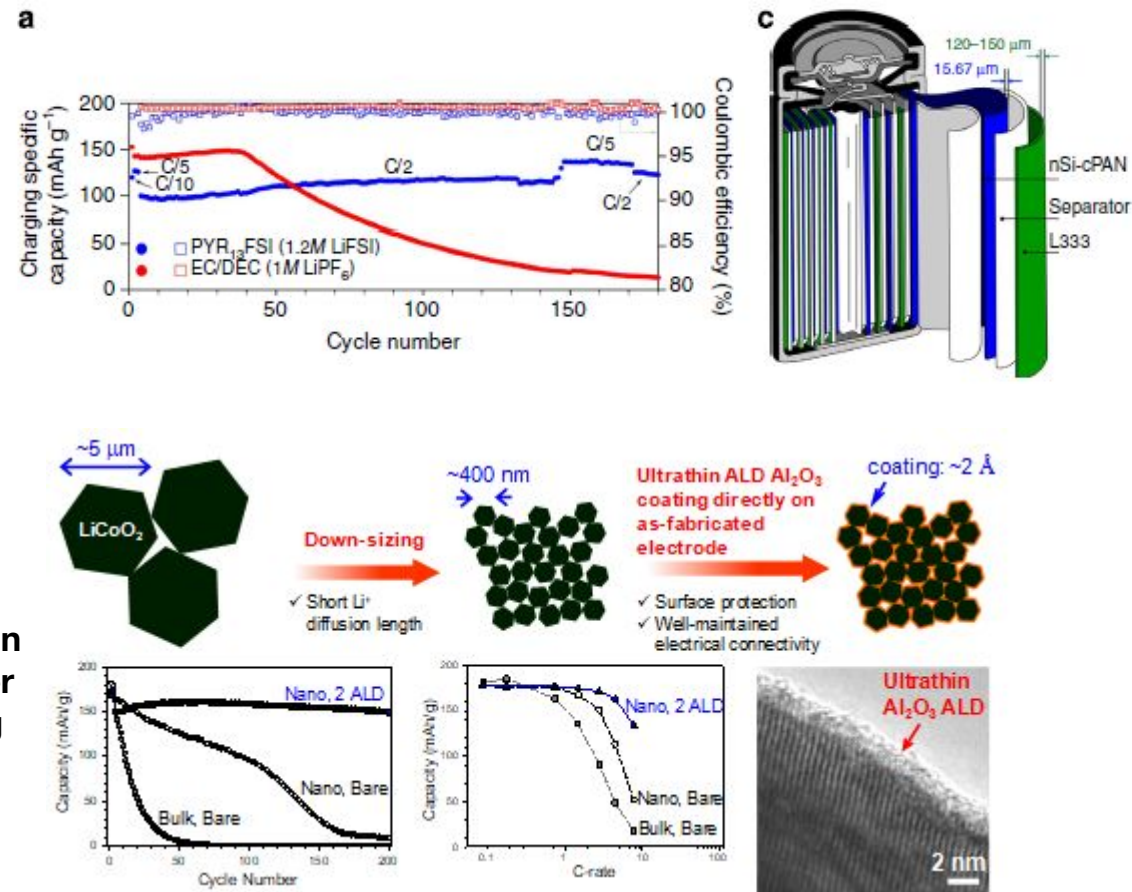



Rong Long

Mechanics of Materials

<https://spot.colorado.edu/~rolo5514/>
rong.long@colorado.edu
303-492-3295

Research at a Glance

My research interest is in the broad area of nonlinear mechanics of soft materials and flexible structures, especially problems that involve fracture, contact, adhesion, friction and multi-physics coupling. We combine experimental testing with theoretical/computational modeling, aiming towards advancing our knowledge in the complex nonlinear behaviors of soft materials and flexible structures. We are also exploring new applications of novel polymer material systems in composite manufacturing and soft robotics.

We aim to advance the fundamental knowledge on the nonlinear mechanics of soft materials and flexible structures, and to address key engineering problems involving soft materials including large deformation, fracture, fatigue, damage, contact, adhesion, and friction.

Adhesion, Friction & Contact

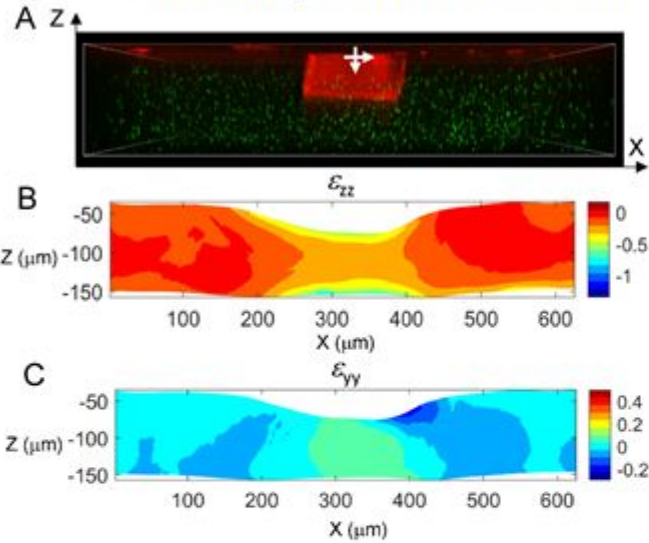

Mechanism & Design

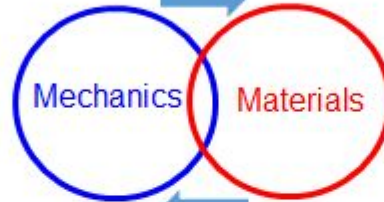

Modeling & Testing

Continuum Mechanics

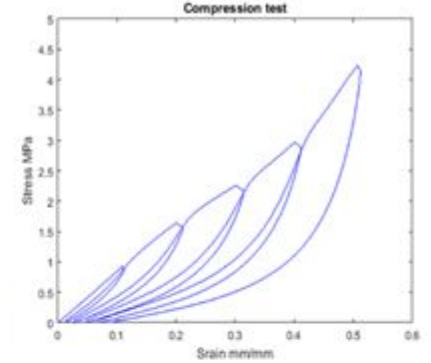
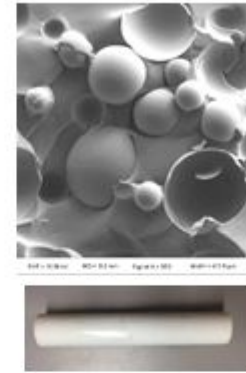

Fracture of Soft Materials

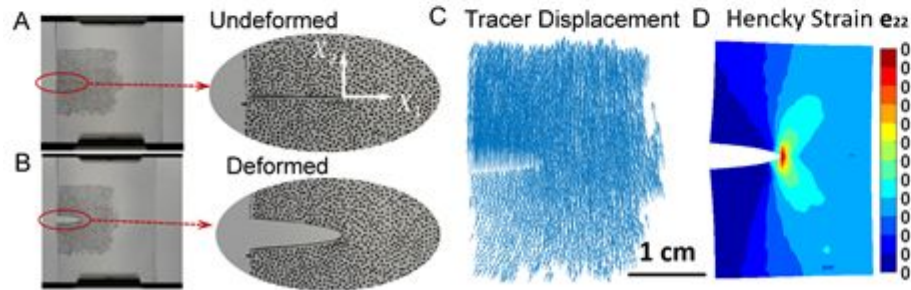

Malleable Fiber Reinforced Composite

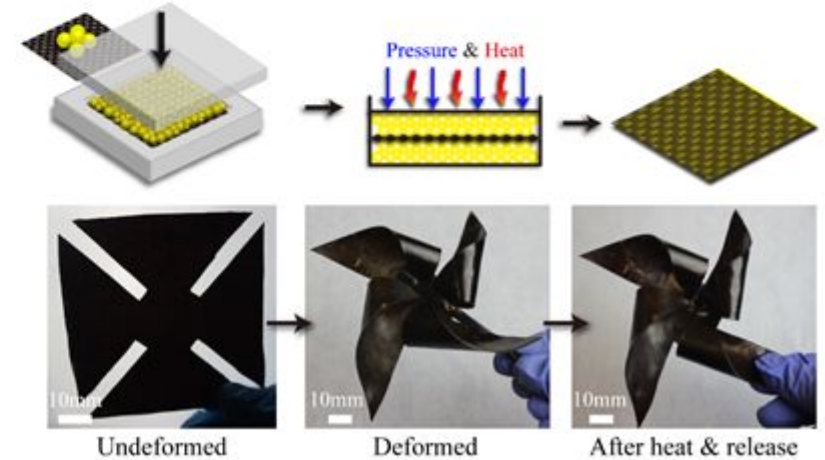



Our long-term goals are to identify novel, mechanically-sensitive therapeutic targets for treating and preventing bone metastases as well as cancer-associated reductions in bone strength.

Maureen Lynch

Biomedical

www.LynchLab.org

maureen.lynch@colorado.edu

303-735-6615

Research at a Glance

My research focuses on the role of the skeletal mechanical environment in regulating breast cancer bone metastasis. The skeleton remodels itself in response to local mechanical forces, which arise due to physical activity. We take multi-pronged approach - in vitro, in vivo, in silico - to study the impact of mechanical stimuli on: i) tumor cells directly, and ii) their signaling with resident bone cells.

Mechanical Regulation of Bone Metastatic Cancer

Breast cancer bone metastasis is highly bone-destructive

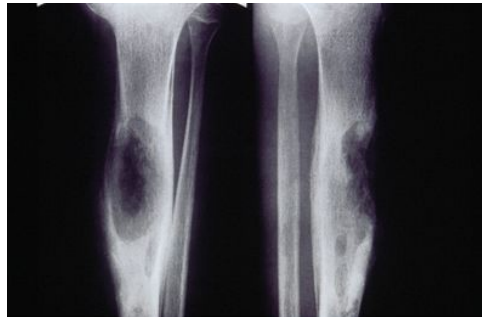

Increased mechanical loading may be anti-tumorigenic

Bone Metastasis + Loading

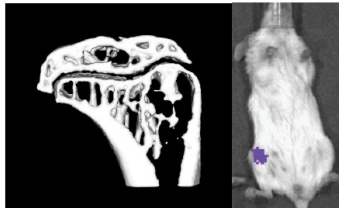

Bone Metastasis

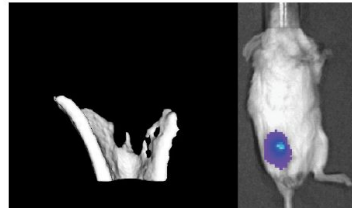

Research Approaches

In vitro multi-modal loading bioreactor

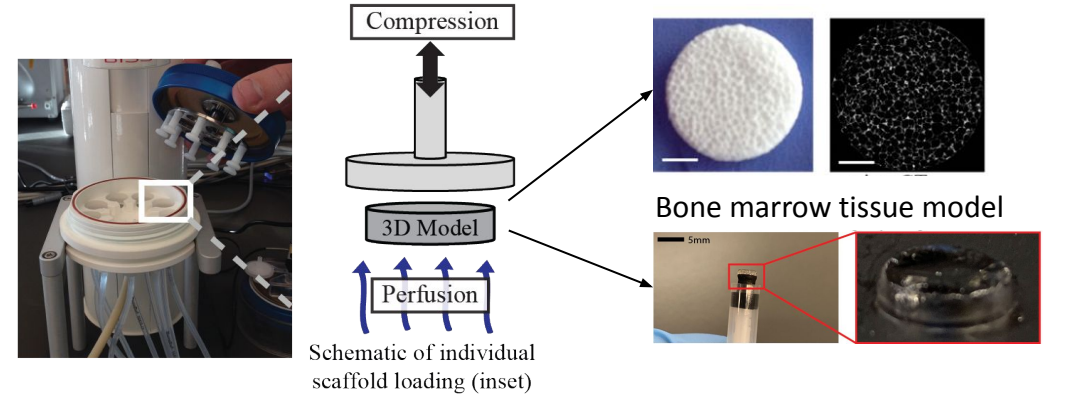

In vivo tibial compression



In silico modeling

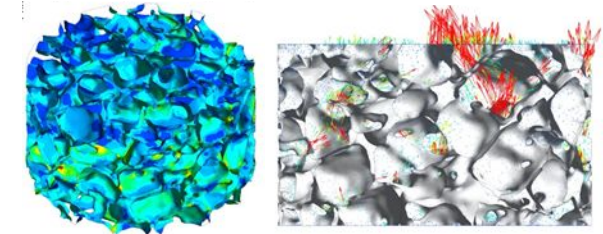

Expertise / Capabilities: Bone biomechanics & mechanobiology; development of in vivo/in vitro/in silico mechanical loading models





Robert MacCurdy

Robotics and Systems Design

www.robertmaccurdy.com

maccurdy@colorado.edu

331-318-0309

Research at a Glance

Our lab is focused on computational design and fabrication: we develop algorithms and automated fabrication methods (multimaterial 3D printing) to automatically design and fabricate functional objects. Imagine a model customized to your body's shape and feel, that a surgeon could use to plan your surgery in advance, or a robot that is ready to use when it emerges from the 3D printer.

The Matter Assembly Computation Lab (MACLab) develops new algorithms, materials, and print methods to enable design and print on-demand of functional artefacts, from personalized surgical planning models to soft robots customized for a specific user's needs.

Spec: "run as fast as possible"

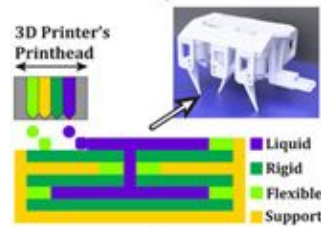
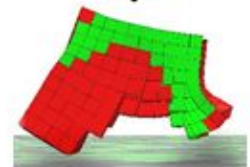

Automated design & fab chain. User provides a loose "desirement," optimization discovers a satisfying design, and custom print tools fabricate it.

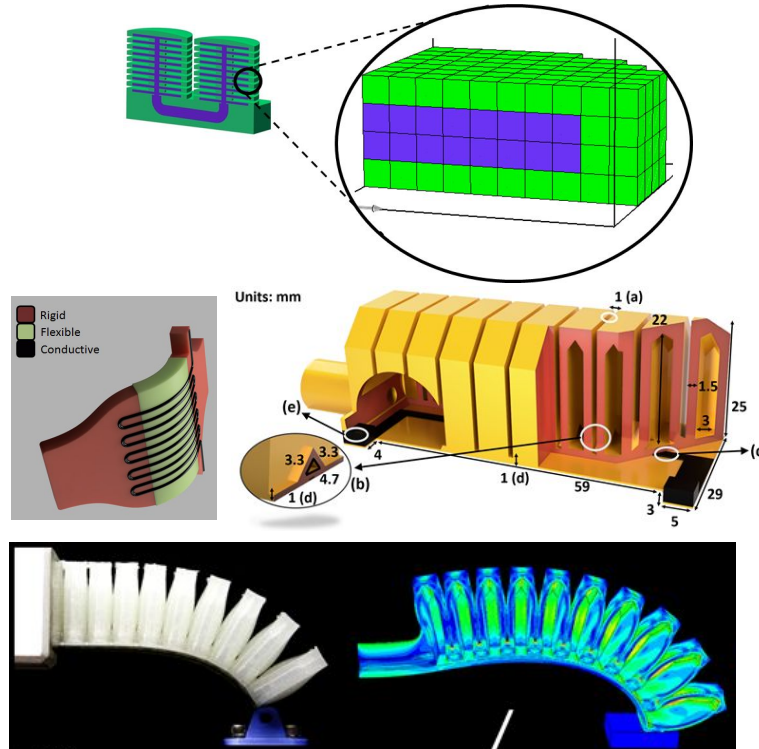

Top: Volumetric (voxel) design allows co-printing with liquids & solids, enabling "printed hydraulics". Middle left: a 3 material design with a compliant hinge and embedded strain sensing. Middle right: a soft, self-sensing pneumatic actuator design 3D printed from 2 materials. Bottom: The printed actuator (L) and a computational model used for design optimization (R)

The MACLab merges computational design and fabrication, with a focus on automation and fabrication scaling.

Our unique capabilities include:

- Two high-throughput, multimaterial inkjet 3D printers: Stratasys J750 (7channels), DCS ElectroUV 3D (8 channels)
- Custom 4-channel direct-write/extrusion 3D printer capable of materials from water to ABS
- Custom volumetric (voxel) design software
- Dual-band laser cutter
- Laser scanning confocal microscope and optical stereo microscope
- Dedicated 128 node compute cluster
- Various electromechanical testbench and commercial simulation tools

Prof. MacCurdy is an expert in optimization-driven multimaterial design automation. He holds a BS in Physics, a BS in Electrical Engineering, and MS and PhD degrees in Mechanical Engineering. While much of our work involves writing design automation software, MACLab members also fabricate and test micro-fluidic devices, design and build new 3D printers, and formulate novel 3D-printable materials.





Hope Michelsen

Thermo Fluid Sciences, Air Quality,
Materials, Micro/Nanoscale
<https://thesootlab.com>
hope.michelsen@colorado.edu

Research at a Glance

The research in my group broadly addresses the formation, evolution, and environmental impact of carbonaceous particles under a wide range of conditions. This work involves studies of soot formation during combustion, black carbon evolution in the atmosphere, and particle synthesis under controlled conditions. It additionally entails development and deployment of laser- and X-ray-based diagnostics and instrumentation for combustion and atmospheric applications.

Our work aims to develop an understanding of soot and other carbonaceous-particle formation in order to reduce their emissions, mitigate their impacts on air quality, human health, and climate change, and control their characteristics for commercial applications.

Soot is responsible for millions of deaths annually, severe degradation of air quality, and enhanced global warming, but it also has significant industrial importance. Despite its ubiquity, the chemical mechanisms by which it is formed are not understood. We focus on experimental and computational investigations to develop a fundamental understanding of soot and other carbonaceous-particle formation under a wide range of conditions.

Our work involves

- Experimental studies of the chemical composition of particles formed during combustion and pyrolysis
- Development of X-ray and laser-based diagnostics for *in situ* observations of particles in flames
- Computational studies of the chemistry of particle formation at high temperatures
- Development of laser-based diagnostics for atmospheric measurements
- Lab-based studies of heterogeneous chemistry and aging of soot
- Field measurements of atmospheric carbonaceous particles

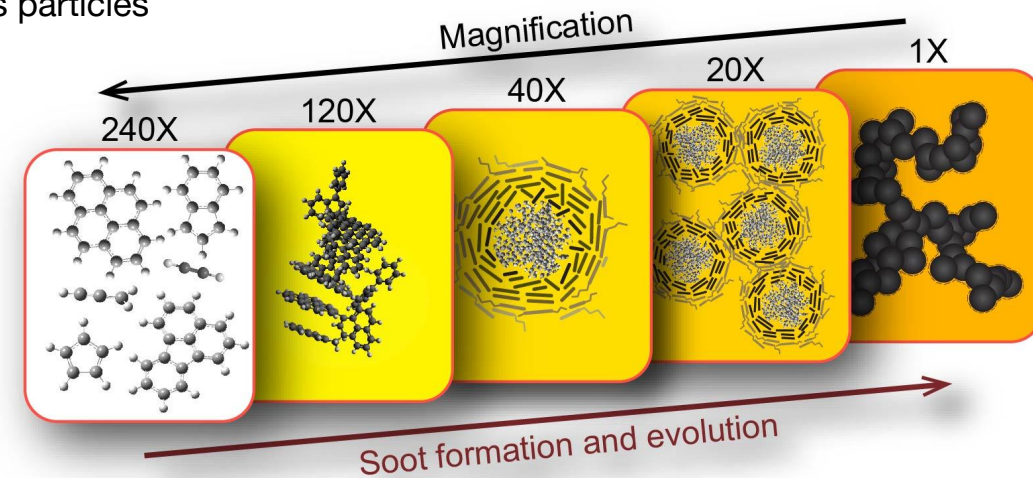

Michelsen et al. ACS Nano 2020



Paul M. Rady
Mechanical Engineering
UNIVERSITY OF COLORADO BOULDER

www.colorado.edu/mechanical/

We develop and apply ensemble-based, computational modeling systems to better understand and predict the chemical composition of the earth's atmosphere. We make extensive use of ground, aircraft, and satellite observations to improve and validate those forecasts.



Arthur Mizzi

Air Quality

arthur.mizzi@colorado.edu
303-735-1003

Research at a Glance

The economic costs of poor air quality (AQ) and climate change in the United States exceed ~\$790 billion (~5% of the US GDP). Our research focuses on the development and application of regional chemical weather forecasting, data assimilation, and emissions adjustment computer modeling systems to better understand, predict, and mitigate poor AQ events. In so doing, we use mathematics, fluid dynamics, thermodynamics, statistics, optimization theory, machine learning, and computer programming/modeling to better protect human health and the environment.

Dr. Mizzi's group uses the Weather Research and Forecasting atmospheric model with online chemistry coupled with the ensemble Kalman filter (EnKF) data assimilation system known as the Data Assimilation Research Testbed (WRF-Chem/DART). WRF-Chem/DART is used by AQ research/forecast institutions and universities through North America, Asia, and Western Europe. Their results show:

- Assimilation of surface observations with emissions adjustment improves AQ forecast skill and predictability.
- Assimilation of surface and satellite observations with emission adjustment improves nitrogen dioxide (NO₂) forecasts near the earth's surface.
- Assimilation of satellite-based NO₂ and formaldehyde (HCHO) observations improves ozone (O₃) forecasts near the earth's surface.

Collaborators: NASA, NOAA, NCAR, UNAM, Nanjing Univ., Shanghai Adv. Res. Inst., Beijing Inst. of Sci. and Tech., UC-Berkley, UMBC, Univ. of Houston, Univ. of MN, and Max Plank Inst. of Met.

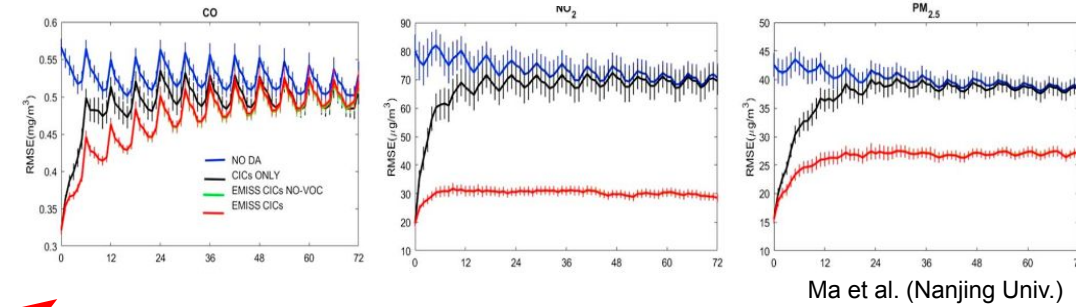

Ma et al. (Nanjing Univ.)

GR-TMSP: MN NO2: FRAPPE

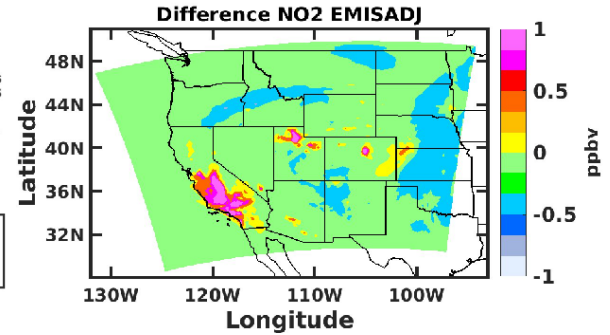
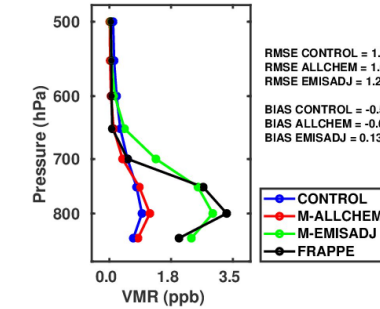

Mizzi et al. (CU Boulder)

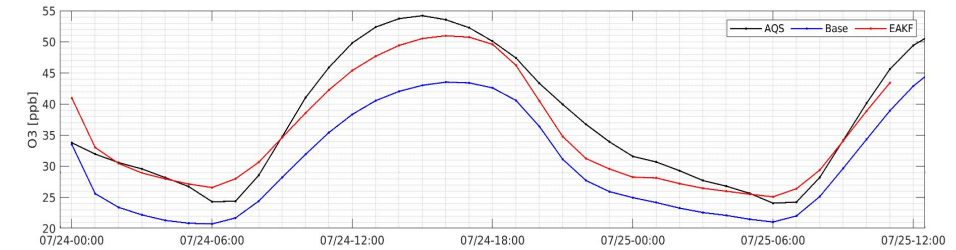

Pouyay et al. (Univ. of Houston)



Shelly L. Miller

Urban Air Pollution
shellym80304.com
shelly.miller@colorado.edu
303-492-0587

Research at a Glance

Professor Miller investigates urban air quality and works diligently to understand the impact of air pollution on public health and the environment. She is an expert on indoor environmental quality including airborne infectious disease transmission and control and air cleaning technologies.

Improving the health and wellbeing of communities by deepening our understanding of the major sources of air pollution and reducing exposure to these pollutants through our actions, strategies, and technology.

- Urban air Pollution and Health Effects
 - NEW: Disruptive events such as road construction are disproportionately impactful environmental justice communities (NSF)
 - NEW: Wildfire smoke exposure impacts healthy aging
 - Urban industrial odors negatively affect wellbeing and sources of these odors can be identified with mobile apps
 - Traffic-related air pollution increase adverse respiratory symptoms
- Building Environmental Quality
 - NEW: Low-cost energy efficient air sensing and cleaning for Navajo communities
 - Households with higher infiltration rates have better lung function
 - Cooking emissions quickly degrade home indoor air quality without local exhaust
- Air Pollution Control
 - NEW: germicidal ultraviolet light - Indoor chemistry and efficacy for disrupting disease transmission
 - Mitigating airborne infections in public buildings
 - Air cleaners reduce indoor concentrations of wildfire smoke and can mitigate bioaerosols



Prateek Blower Door



Traffic Air Pollution Sampling





Flow physics, living systems, organized behavior - these themes define our mission of impacting human health using interdisciplinary tools and technologies; and educating future engineers from diverse backgrounds to tackle grand challenges in human health.

Debanjan Mukherjee

Biomedical, Thermo Fluid Sciences

www.flowphysicslab.com/
debanjan@colorado.edu

303-735-8368

Research at a Glance

As FLOWLab at CU Boulder, we engage in interdisciplinary investigations on complex flow physics and transport phenomena. We seek to unravel how flow physics influences phenomena involving living systems. Within this theme, we study flow and mechanics of physiological processes in health and disease; efficacy of treatment approaches; medical device and drug delivery; and infection transmission and control. We are also interested in fundamental advancements in computational mechanics approaches for flow physics, particulate media, and particle-laden flows.

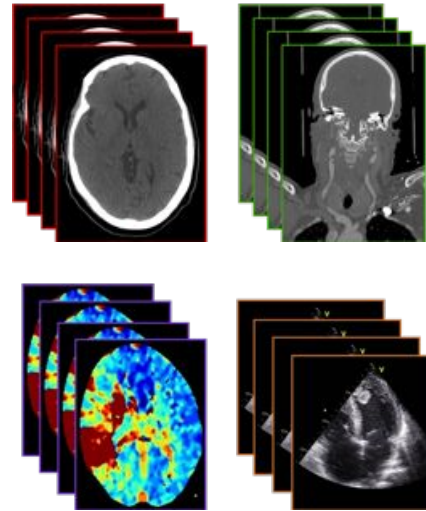

Medical Image-based Modeling

Thrombosis and Blood Clot Mechanics

Stroke and Cerebrovascular Flows

Vascular Flow & Transport in Large Vessels

Infectious Disease Transmission & Control

Vascular Drug Delivery

AND THE NEXT NEW PROJECT ... !!

FLOWLab CURRENT RESEARCH PROGRAM



Computational Flow Physics Modeling

Fluid-particle & Fluid-structure Interactions

Lagrangian and Particle-based Analysis

Quantitative Image Processing

Medical Image-based Modeling

3D-printing & Bench-top Flow Loop Experiments

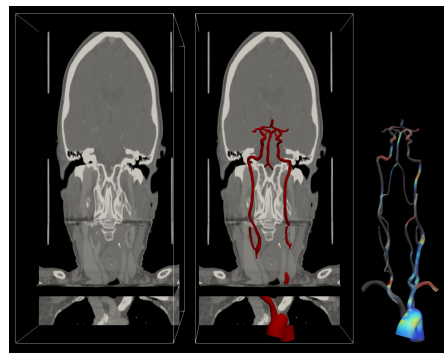

Stroke & Cerebrovascular Flows

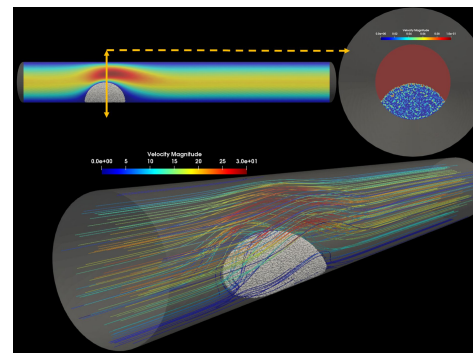

Blood Clot Biomechanics

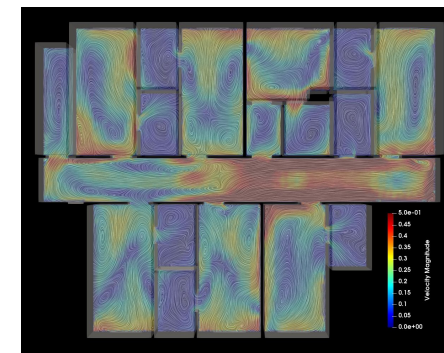

Indoor Airflow & Infections

*Interested in working with us?
Visit our website, or email debanjan@colorado.edu
We would love to hear from you!*



John Pellegrino

Thermo Fluid Sciences, Materials
www.colorado.edu/faculty/pellegrino
john.pellegrino@colorado.edu
303-735-2631

Research at a Glance

My research revolves around fundamental membrane development, characterization, and applications. We study how the properties of the membrane, the streams, and the choice of operating conditions control the separations and productivity results. We explore new concepts and the materials that may make them viable. Our lab improves membranes and creates new processes or devices for applications in water and the environment, energy storage and production, bioprocessing, food, and biomedical.

Sustainable and economically attractive processes and devices rely on membranes.

Expertise

- membrane characterization
- transport processes for gas and liquid species
- speculative material & process synthesis

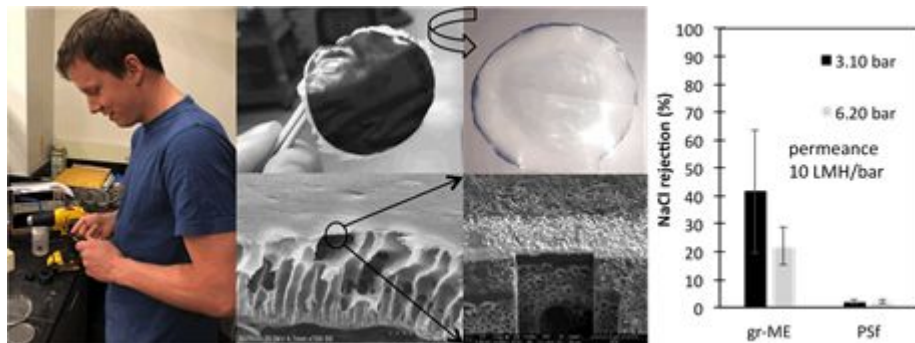

Unique capabilities & facilities

- gas-liquid porometry
- roll-off angle metrology
- roll-to-roll embossing and stamping
- high pressure, membrane transport metrology

Ideas

- Powering biomedical devices with the body's glucose

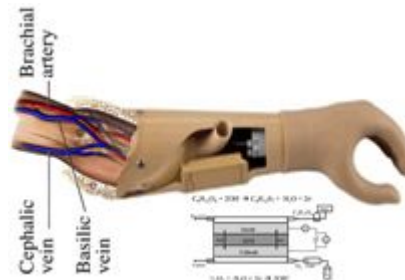

Commercial activities

- Pure Blue Tech licensed: Enhancing filtration performance of membranes with nanoscale patterns. U.S. Patent No. 10,369,525 (2019).

Illustrative current projects

- scale-up and testing of membranes containing regular surface patterns produced with nanoscale dimensions;
- engineering research studies on the crystallization processes inherent in water recovery and reuse associated with zero-liquid-discharge;
- and creating alkaline fuel cells using glucose to power prosthetic devices.

Our lab engages with industrial partners through:

- NSF/IUCRC Membrane Science, Engineering and Technology (MAST) Center;
- Joint proposals to NSF, DOE, US Bureau of Reclamation, and DoD including GOALi, SBIR, and STTR;
- Direct contracts and Service agreements.





Mark Rentschler

Biomedical, Mechanics of Materials,
Robotics and Systems Design

amtl.colorado.edu

mark.rentschler@colorado.edu

303-735-6149

Research at a Glance

In striving to improve the quality of life for patients, our research focuses on fundamental understanding of key questions to enable intelligent medical devices and surgical robotics which are, in turn, setting a foundation for patient-specific medical care and ultimately leading toward an operating room of the future. These efforts include design of novel surgical tools, devices, and robotics; characterization and modeling of how these tools, devices, and robots interact with the patient; and optimization based on these models.

Through our research in the Advanced Medical Technologies Laboratory we strive to improve the quality of life for people by reducing surgical and medical procedure invasiveness, improving physician's capabilities, and reducing overall medical costs.

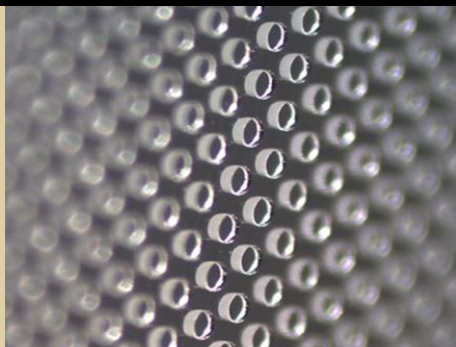

MICRO-TEXTURING

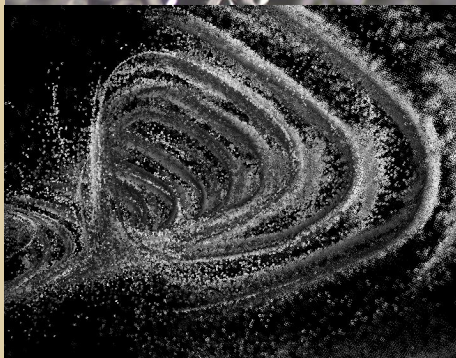

SMART HEALTH

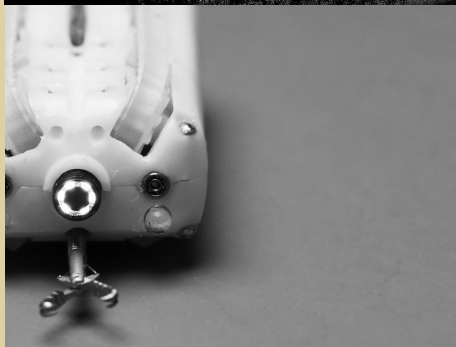

ROBOTIC ENDOSCOPY

CONSULTING

Mark Rentschler is a professor, entrepreneur, inventor, program director, design engineer, roboticist, expert witness, and seasoned engineering consultant. He has over 15 years of leadership in mechanical and biomedical engineering consulting and intellectual property development. He is a published subject matter expert focused on medical devices, surgical robotics, mechanical design and mechatronic design and control. He has served as an expert witness in numerous patent litigation and personal injury cases.

ENTREPRENEURSHIP

In 2018, Mark Rentschler and Steven Edmundowicz (Professor of Medicine at CU Anschutz Medical Campus) founded a CU technology spin-out, Aspero Medical, with the goal of translating their research from benchtop to bedside to *complete GI endoscopy procedures the first time*.

As CEO of Aspero, Dr. Rentschler is leading a dynamic team through FDA approval and initial sales launch. More details at asperomedical.com.



Paul M. Rady
Mechanical Engineering
UNIVERSITY OF COLORADO BOULDER

www.colorado.edu/mechanical/



Laser Technologies to Transform and Improve Our Future.

Greg Rieker

Thermo Fluid Sciences, Air Quality
www.colorado.edu/lab/rieker
greg.rieker@colorado.edu
303-492-6802

Research at a Glance

Research in Greg Rieker's Precision Laser Diagnostics Laboratory aims to understand and improve real-world systems through laser-based sensing. The laboratory places strong emphasis on entrepreneurship in academic pursuits, from challenging the traditional ways that research has been carried out in a particular field, to actively commercializing technologies that can have a positive impact on our future.

Activities of the Precision Laser Diagnostics Laboratory:

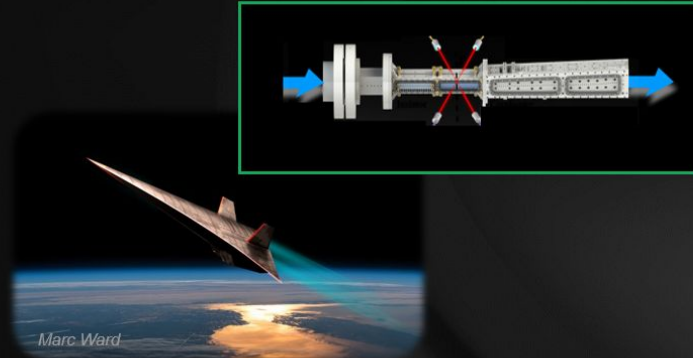

Hypersonic Propulsion



Quantum Sensor Networks

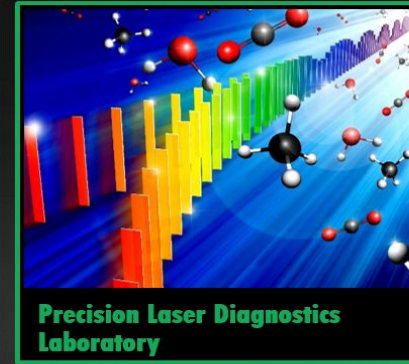

Precision Laser Diagnostics Laboratory

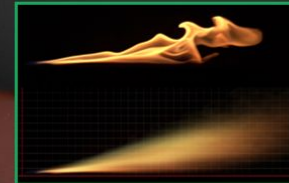

Wildfire Dynamics



Atmospheric Sensing



Exotic Environment Spectroscopy

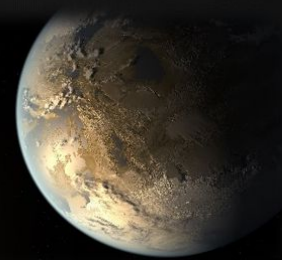



Our goal is to enable new and improved design, characterization and inspection procedures for mechanical, transportation and biological systems by studying their dynamic behavior under different environmental conditions.

Massimo Ruzzene

Mechanics of Materials

www.colorado.edu/faculty/ruzzene

massimo.ruzzene@colorado.edu

303-735-0424

Research at a Glance

Our research group specializes in structural dynamics and wave propagation. We experimentally and theoretically investigate smart solutions and materials for wave guiding and manipulation, acoustic absorption, transducer design, vibration isolation and noise reduction. Examples include aircraft components, magnetostrictive materials and periodic metastructures. We also apply dynamic methods for the inspection and characterization of mechanical systems and biological tissues such as bonded composite joints and the human skull.

Aero-Adaptive wings

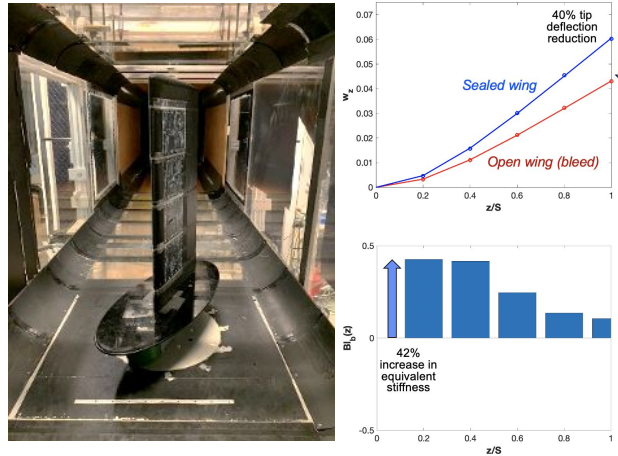

Guided waves in the human skull

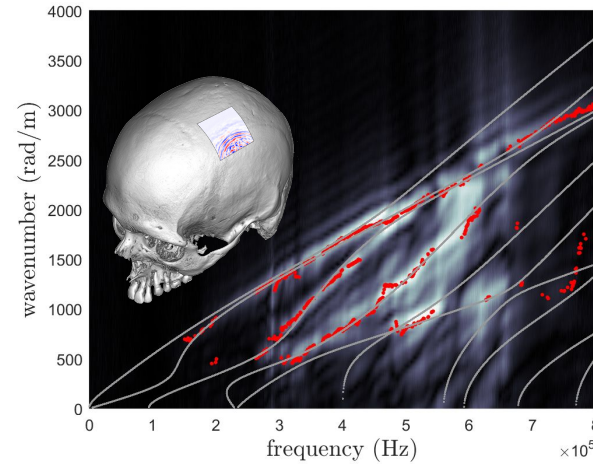

Composite and magnetostrictive materials

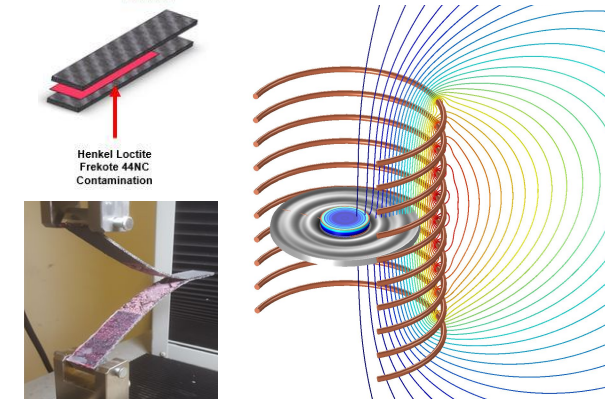

Physics of non-Hermitian active media

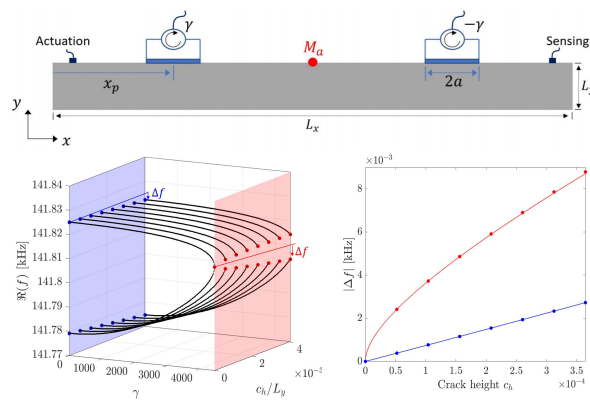

Dynamics of quasi-periodic media

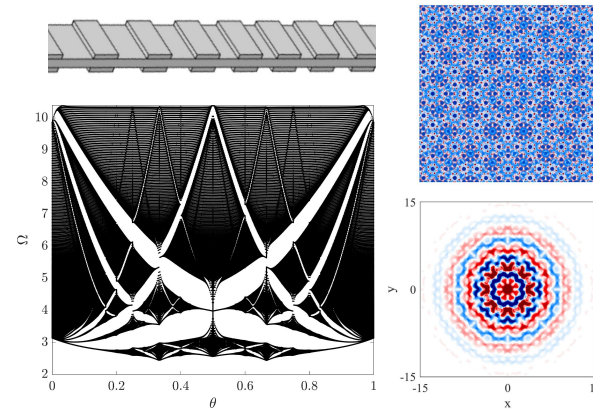

Vibro-Tactile communication in collaborative micro-bots

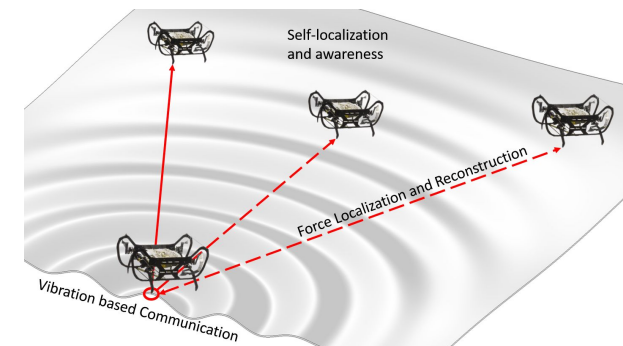

I create artificial limbs that blur the lines between human and machine by plugging into the nervous system.



Jacob Segil

Neural Interfaces, Prosthetic Limb Design

<https://www.colorado.edu/faculty/segil/jacob.segil@Colorado.edu>
303-735-7313

Research at a Glance

My research mission is to enable the embodiment of artificial devices by providing physiologically appropriate somatosensory feedback. Using neural interfaces, biomechatronic devices, and machine learning, I plan to blur the lines between human and machine by eliciting perceptions of our natural body using the artificial devices.

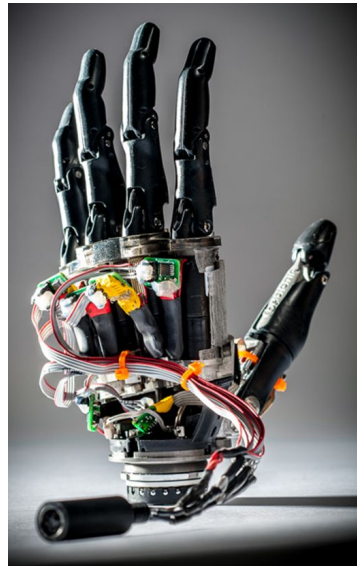

Current Research

- Investigation of Embodiment of Prosthetic Hands (VA RR&D, 5 years)
- Semi-Autonomous Control of Prosthetic hands (NIH STTR, 1 year)
- Development of Surgical Tooling for Hip Arthroscopy (CO OEDIT, 1 year)



Entrepreneurial Ventures

- 8 patents and applications all licensed to partnering startup companies
- Founder and CTO, MITA LLC acquired by [Stryker](#) in 2017 ([link here](#))
- Founder, [Point Designs LLC](#) a provider ratcheting prosthetic fingers



Wei Tan

Biomedical

www.colorado.edu/lab/tan/

wei.tan@colorado.edu

303-492-0239

Research at a Glance

Vascular Bioengineering laboratory is mainly interested in the interdisciplinary research at the cross-section of nano-materials and material mechanics with vascular medicine.

We develop biomaterials, in particular micro/nano-biomaterials, and leverage the biomaterials technologies to innovate medical devices and 3D biomanufacturing processes, with an ultimate goal to transform cardiovascular treatment.

Engineering
Technology

Translate

Biomedical
Applications

Biomimetic Materials

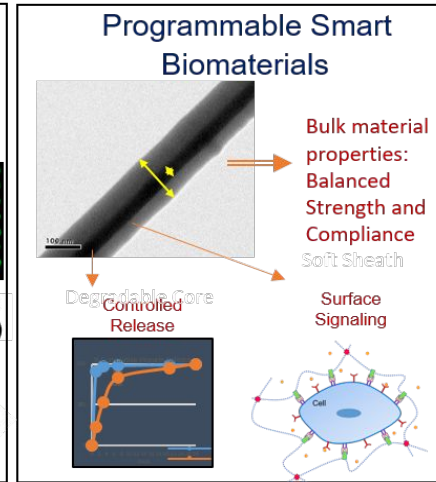
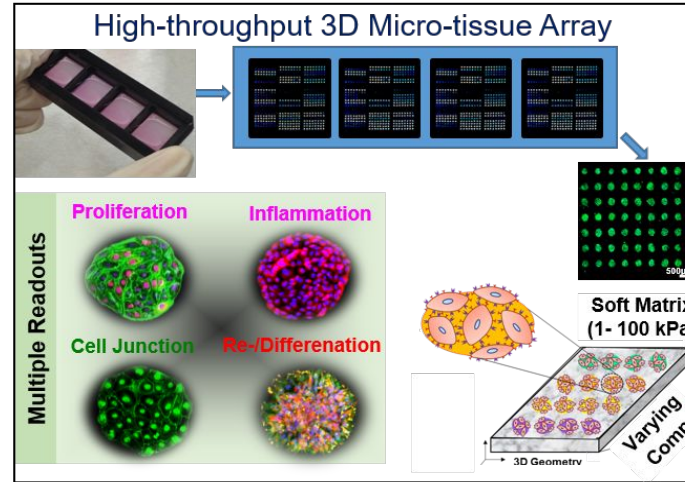

Vascular Flow

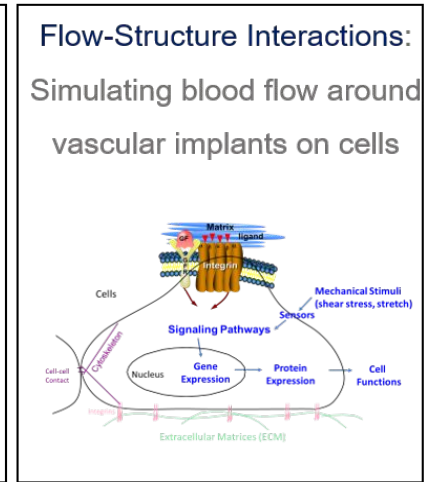

Cardiovascular Devices

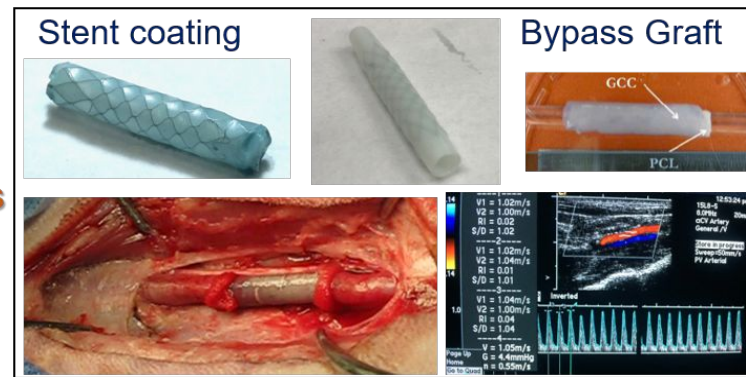

3D Fabricated Models for Drug Discovery

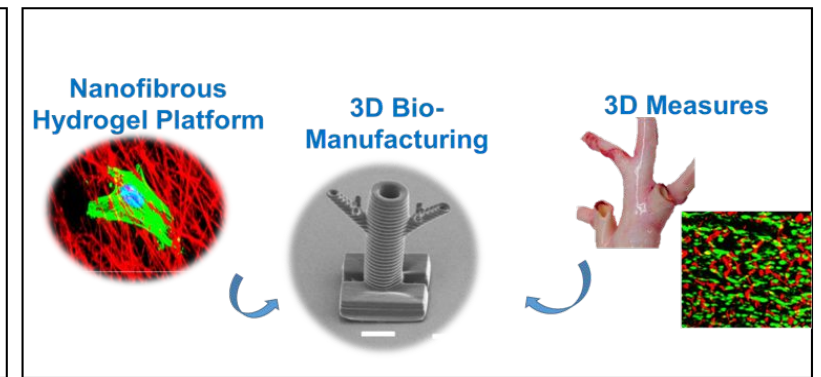



Marina E. Vance

Air Quality, Micro/Nanoscale
www.colorado.edu/lab/vance
marina.vance@colorado.edu
303-735-4567

Research at a Glance

Our research focus is in Air Quality, especially Aerosols in the context of ambient and indoor air quality.

Applications of our research include physical transformations of aerosols indoors and outdoors and assessing emissions to reduce human exposure and to inform "safer by design" consumer products.

Our mission is to perform research that will lead to a positive impact in human health and the environment.

We employ engineering tools perform experimental research on aerosol physical properties in the laboratory and in the field to minimize human and environmental exposure.

Our Expertise:

- Studies on the formation, transport, and fate of aerosols, ranging from single-nanometer to tens of micrometers in size.
- Evaluation and use of low-cost sensors for air pollution measurements indoors and outdoors.
- Assessment and minimization of people's exposure to environmental contaminants.
- Ambient and source aerosol sampling and characterization.
- Understanding the release of nanomaterials or aerosols from consumer products.

Our capabilities:

- Experimental measurements of aerosols in controlled chambers, in real indoor environments, and outdoors using real-time and offline instrumentation.
- 38 m³ aerosol test room chamber for emissions testing.
- Expertise in modeling of indoors aerosol emissions and inhalation exposure.

For more information, visit: www.colorado.edu/lab/vance

Example projects:

Mask & respirator testing during the COVID19 pandemic:

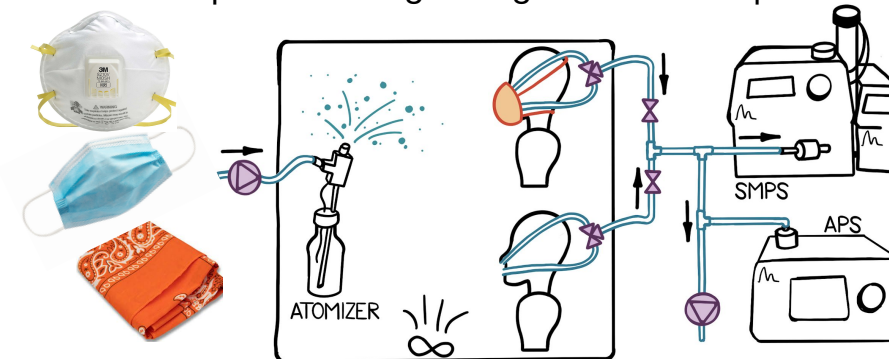

Particle concentrations during an indoor cooking event:

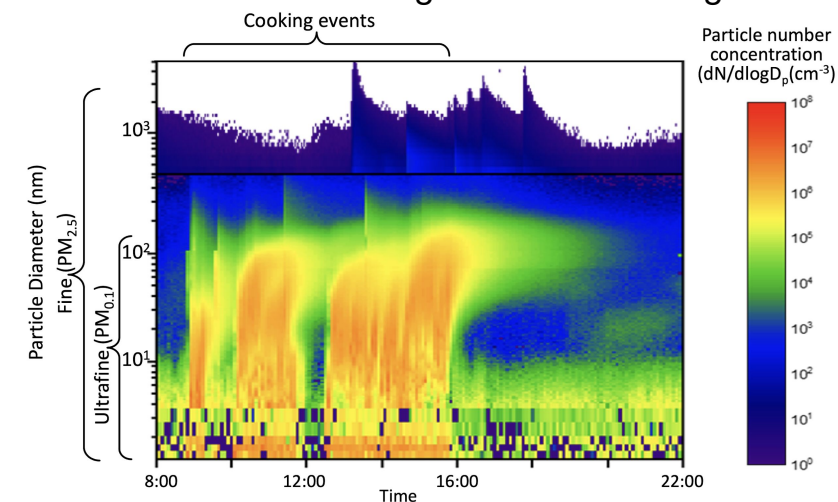



Franck Vernerey

Mechanics of Materials, Biomedical
<https://www.colorado.edu/lab/vernerey>
franck.vernerey@colorado.edu
 303-492-1270

Research at a Glance

Our research focus is theoretical, computational, and applied mechanics of intelligent biological and bio-inspired matter.

Applications of our research include the development of new models that will guide the development of smart polymers and hydrogels for tissue engineering, the study of diseases, and soft robotics.

Our mission is to advance the fundamental knowledge of soft matter mechanics and apply it to biotechnology and human health.

Our aim is to fundamentally understand the link between molecular interactions and the mechanical behavior of biological and bioinspired materials, including deformation, flow, fracture, self-healing, growth, and morphing.

We are an interdisciplinary team working across the fields of mechanics, physics, biology, and materials science to elucidate the complex behavior of soft materials. We develop arrays of multiscale theoretical and computational approaches to link the structure-property relationship of bio and bio-inspired polymers, with applications in bioengineering, cell mechanics and active solids. Our current work ranges from fundamental to applied research with focus on:

1. Mechanics, adhesion, and fracture of polymers with dynamic bonds.
2. Mechanics of active and programmable matter.
3. Cell mechanics.

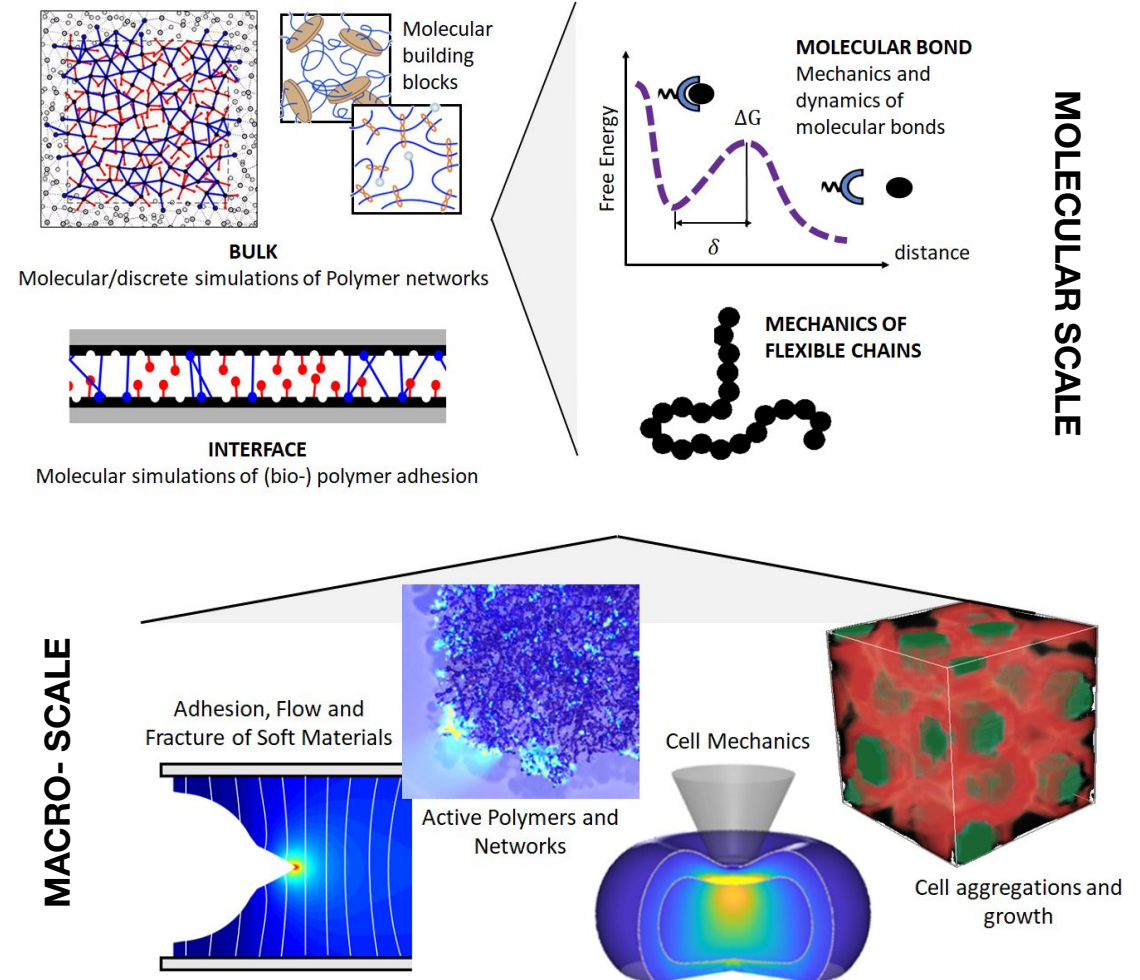



Nathalie Vriend

Thermo-Fluids, Mechanics of Materials
<https://www.colorado.edu/mechanical/nathalie-m-vriend>
nathalie.vriend@colorado.edu
720-431-1662

Research at a Glance

Our research involves detailed laboratory experiments and targeted field work involving particulate flows such as sand and snow, complemented with numerical simulations and theoretical modelling.

I have active projects in granular rheology and avalanching, and dune structure and migration. In the past, I worked on the dynamics of real snow avalanches, singing sand dunes, silo honking and seismic wave propagation.

Our aim is measure, characterize and model granular flows to mitigate natural hazards of geophysical mass flows and reduce economic losses in industrial processes.

1. Photoelastic avalanches: rheology of granular flows

In my laboratory, we obtained high-quality dynamic measurements of both velocity and stress fields in fast avalanches using photoelasticity. This approach is original and novel: we are the first in the world to experimentally probe the stress state in fast, dynamic processes. This was feasible due to two novel developments: (a) we fabricate bespoke, superior-quality birefringent photoelastic particles and (b) we conduct experiments at a high frame-rate (up to 10,000 fps) and analyse the data with a non-equilibrium force algorithm.

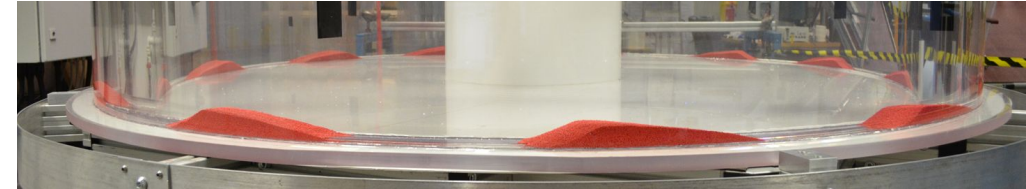
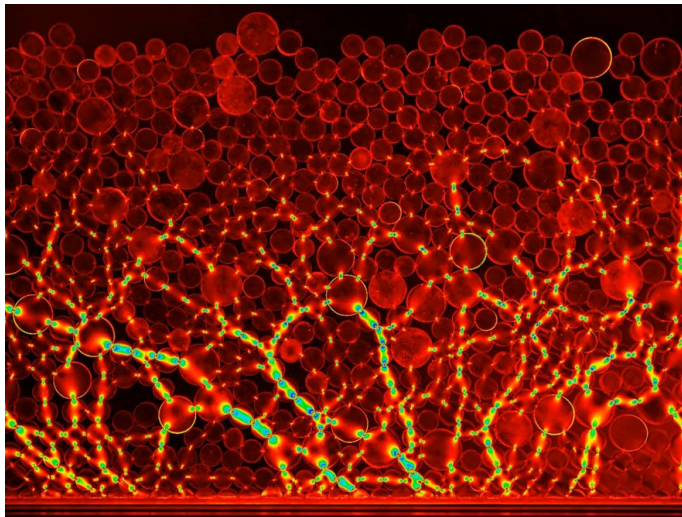

2. Sand dunes in a 1D annulus: dune interaction & migration

Our experiment is the first of its kind and generates enticing novel empirical data, allowing mathematical analysis at the cutting-edge of our field. Our approach is novel: by using a recirculating geometry we avoid sand supply problems encountered in linear flumes and we can perform experiments for long periods.

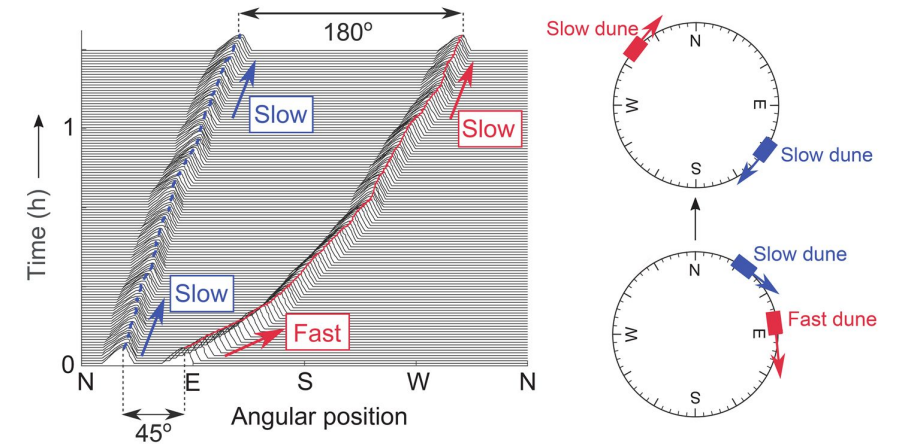

Our mission is to advance understanding of the human sensorimotor control system and human-device interaction in order to effectively develop devices that assist those with movement impairments or augment everyday movement to reduce fatigue or injury.



Cara Gonzalez Welker

**Biomedical, Robotics
and Systems Design**

Lab website coming soon!
cara.welker@colorado.edu

Research at a Glance

My research group will take an interdisciplinary approach combining expertise in biomechanics, haptics, and robotics in order to develop assistive devices that more effectively interface with the complex human sensorimotor control system.

Exoskeletons

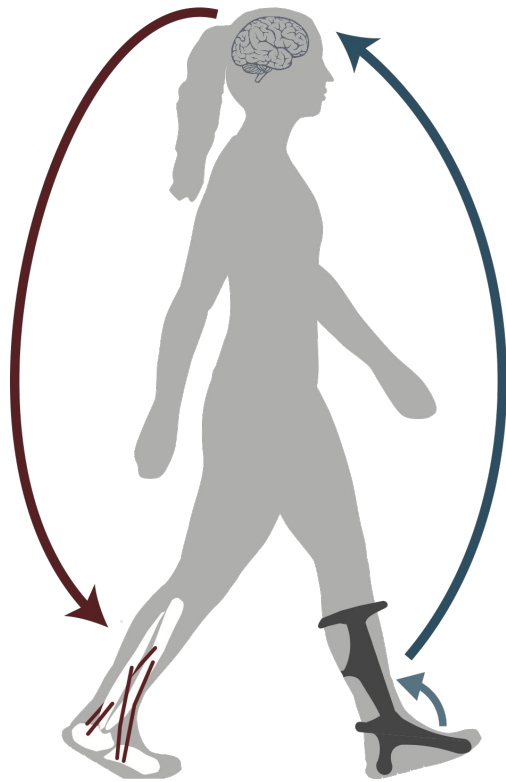

Expertise:

- Biomechanics
- Haptic device design
- Biomimetic device control and biofeedback
- Human subject experiments
- Musculoskeletal modeling

Projects:

- A novel haptic device to provide feedback from a robotic prosthesis
- Enabling volitional control of assistive devices to gain insight into the human cost function during walking
- Optimizing control parameters for robotic prostheses
- Characterizing human perception during different types of motion

Prostheses

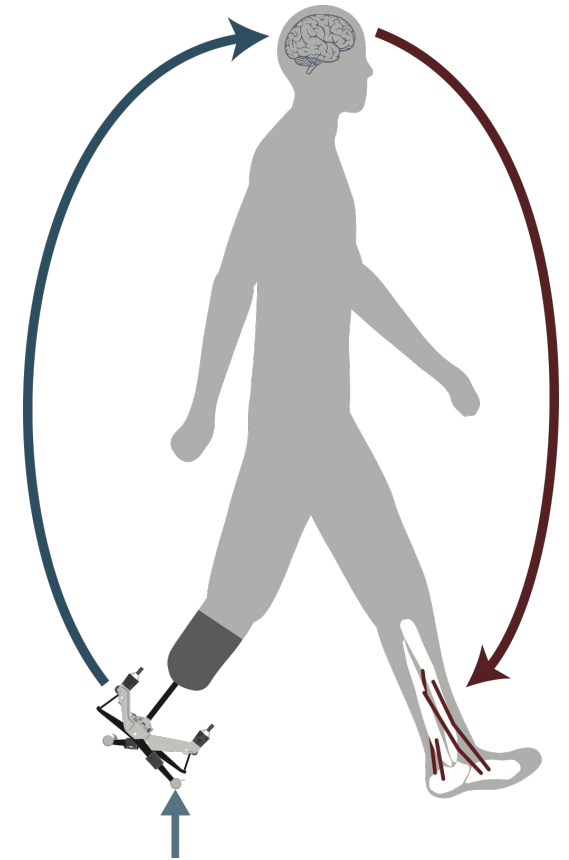



Using additive manufacturing techniques, we can engineer unconventional electronic systems able to address a wide range of important issues in areas including agriculture, energy generation, robotics, assistive technologies, and off-planet manufacturing.

Gregory L. Whiting

Materials, Micro/Nanoscale
www.colorado.edu/lab/whiting
gregory.whiting@colorado.edu
303-735-7617

Research at a Glance

My group's research is focused at the intersection of novel electronic materials, additive manufacturing, and functional devices. We use printing as a method to fabricate unconventional electronic components and systems that can have properties such as being biodegradable, tightly integrated and multifunctional, readily customized, mechanically flexible/conformable, large-area, and can be widely distributed. We use these devices for applications in areas such as agriculture, off-planet manufacturing, energy generation, assistive technologies, and robotics.

Soil and Plant Sensing

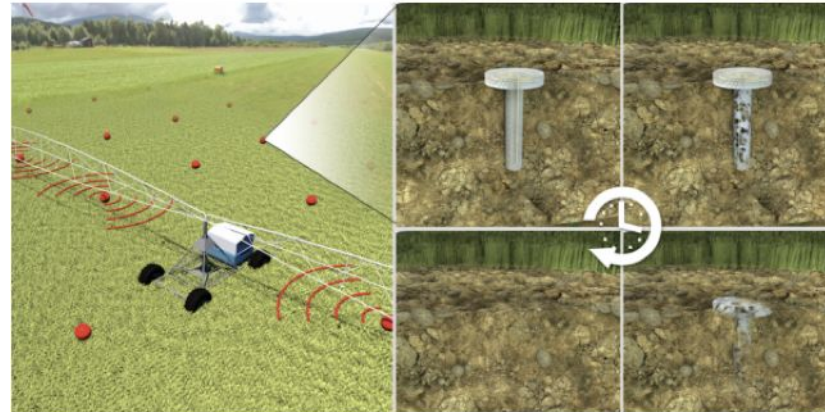

Flexible and Wearable Electronics

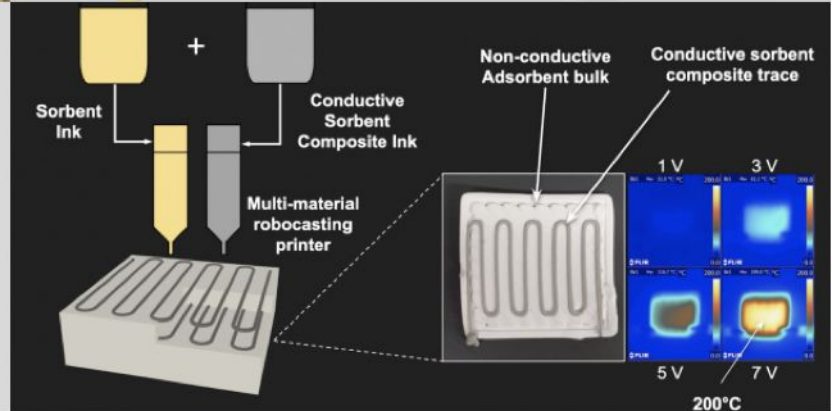
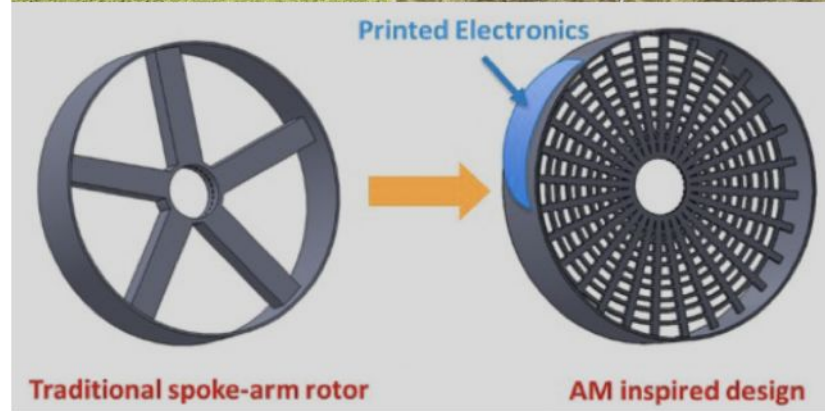
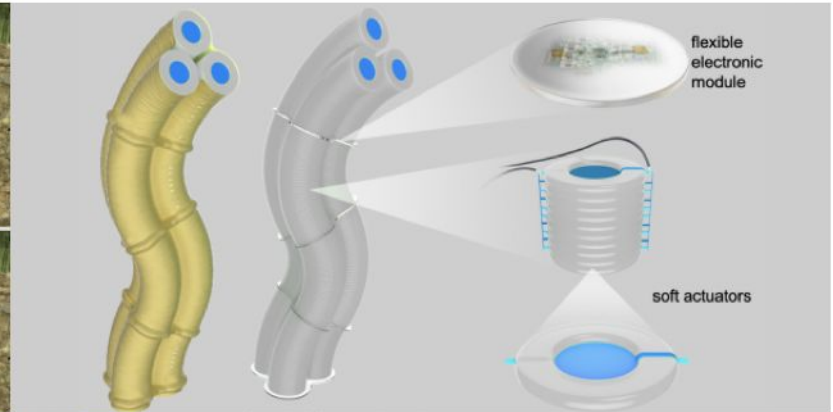

Functional 3D Printing

Off-Planet Manufacturing



Christine Wiedinmyer

Air Quality

<https://cires.colorado.edu/administratio>
[n/christine-wiedinmyer](https://cires.colorado.edu/administratio/n/christine-wiedinmyer)
christine.wiedinmyer@colorado.edu
303-735-5741

Research at a Glance

Dr. Wiedinmyer's research focuses on the emissions of air pollutants into the atmosphere and their impacts on air quality, climate and health. Dr. Wiedinmyer has created the Fire INventory from NCAR (FINN), a high resolution emissions model of wildfire emissions for use with air quality and climate models. Dr. Wiedinmyer's research activities have also included investigation of the emissions from cooking in developing countries, emissions from open waste burning, and emissions from other incomplete combustion sources.

We develop tools to predict the emissions of air pollutants and to examine their impacts on air quality, climate and health so that we can develop the best mitigation strategies to improve air quality, understand climate change processes, and benefit public health.

Our Activities Include:

- Development of air pollutant emissions inventories for input to air quality and climate models.
 - Global open waste burning emissions:
<http://bai.acom.ucar.edu/Data/fire/>
 - [DICE-AFRICA](#)
- Estimating air pollutant emissions from open burning, at local, regional and global scales.
 - [FINN](#)
- Examine air quality impacts from wildfires
- Assess the impacts of open burning for residential heating and cooking
 - [REACTING](#)

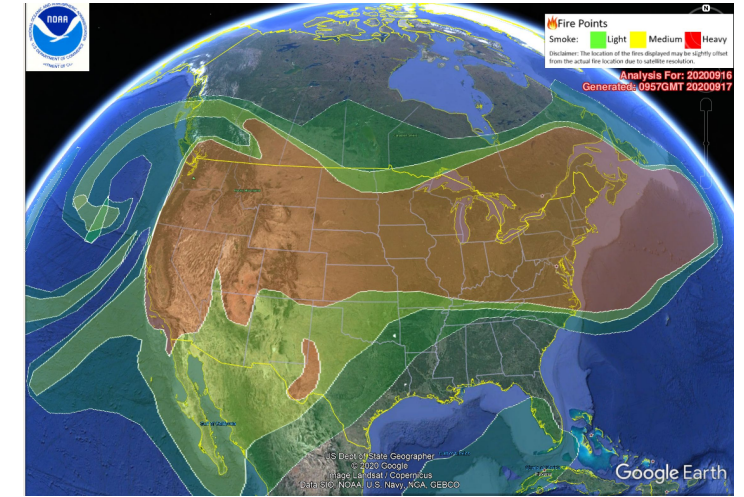

Flexible wearable devices can help solve some of the biggest healthcare problems, including self-health monitoring and preventive medicine, and thus can greatly improve patient care and experience. The self-healing and recycling capabilities ensure long-term reliability and minimal environmental impact.

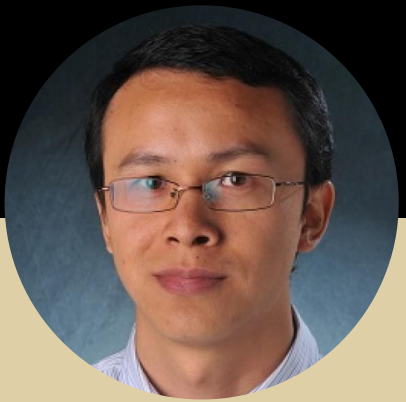

Jianliang Xiao

**Mechanics of Materials,
Micro/Nanoscale**

<https://www.colorado.edu/lab/xiao/jianliang.xiao@colorado.edu>
303-492-5428

Research at a Glance

Our research focuses on bridging hard and soft materials, to foster new devices, systems and technologies. Specifically, we are interested in: Design and fabrication of stretchable/flexible electronics and optoelectronics; Integration of hard and soft materials to create smart soft machines; Bio-integrated and bio-inspired devices; Mechanics of thin films on compliant substrates; Mechanics of nanomaterials.

- Superior flexibility and stretchability for wide applicability
- Multifunctional and integrated devices
- Self-healing, recycling and reconfiguration
- Design and mechanical optimization

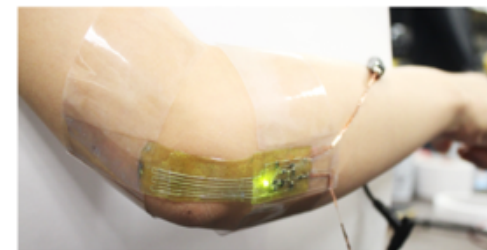
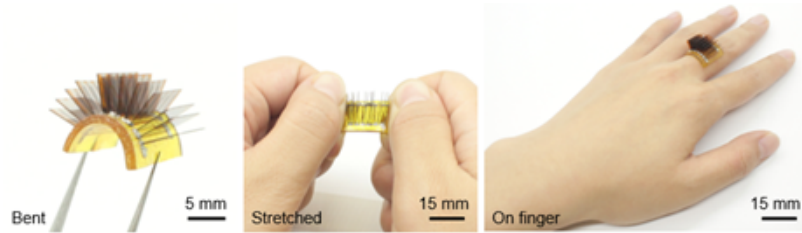
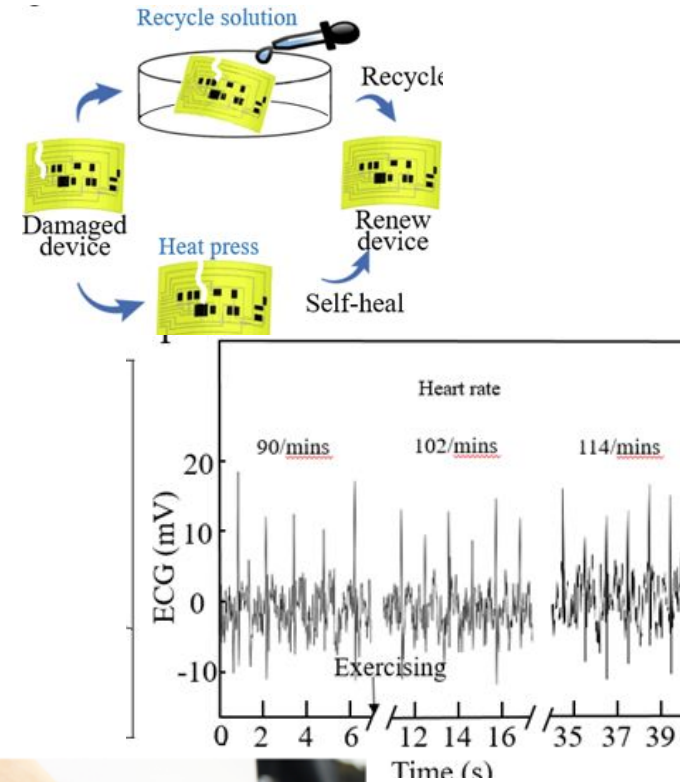
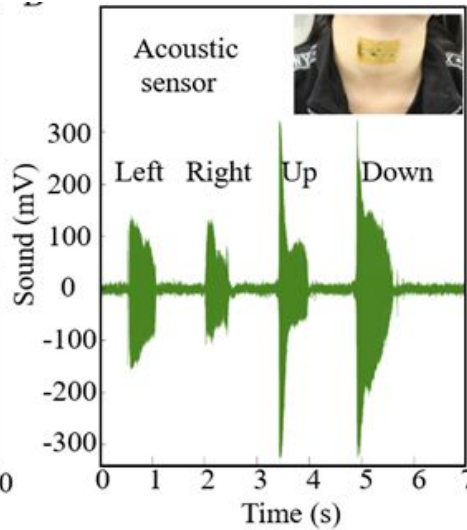
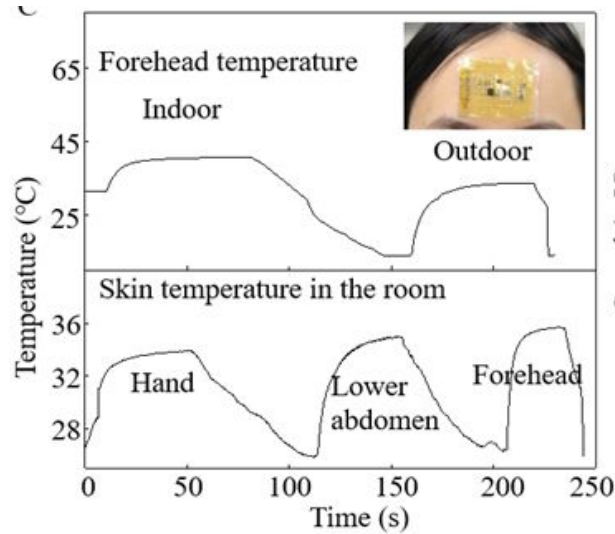



Nicole W. Xu

Robotics and Systems Design,
Thermo Fluid Sciences
www.nicolexulab.com
nicole.xu@colorado.edu

Research at a Glance

The Xu Lab is an interdisciplinary research group at the intersection of robotics, fluid dynamics, and biology. Our goal is to design and implement swimming robots in real-world environments for applications such as ocean conservation and observing natural phenomena. To do this, we apply principles from nature, which have been honed over millions of years of evolutionary pressure, onto engineered systems to create bioinspired aquatic robots and underwater vehicles.

Our mission is to develop and deploy bioinspired aquatic robots to monitor the ocean and track climate change. By combining features from both natural and engineered designs, we aim to create more energy-efficient, maneuverable, and robust robots to aid in environmental stewardship.

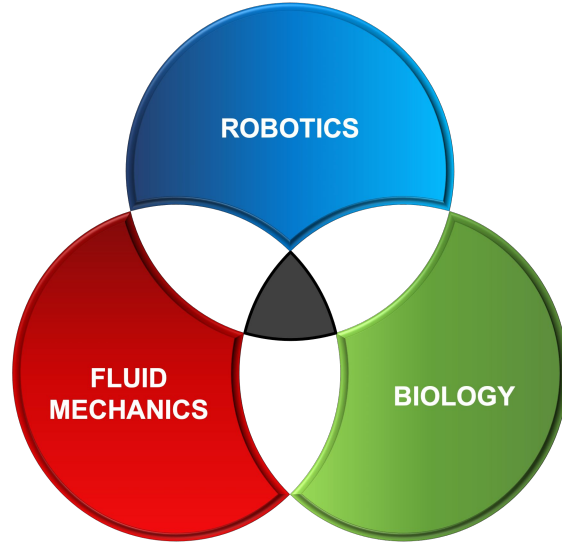

Research Projects

Expanding tools to explore different areas of the ocean

Biohybrid robotic jellyfish for ocean monitoring

Improving persistence and maneuverability in underwater vehicles using bioinspired features

Shark-inspired surfaces for turbulent drag reduction

Robotic fish fins for thrust production in near-shore applications

Areas of Expertise

Bioinspired and biohybrid swimming robots and underwater vehicles

Experimental fluid dynamics

Theoretical and physical modeling

Field work in coastal and ocean environments

